

ROBAM

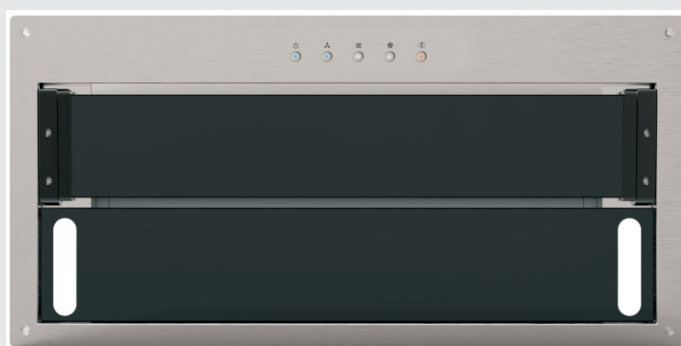

使用说明书 User Manual

使用产品前请仔细阅读本使用说明书，并妥善保管。如果说明书丢失，您可以发送邮件至 overseas@robam.com，获取电子版说明书。

Before operating this unit, please read the user manual completely and keep it. If the manual is lost, you can send e-mail to overseas@robam.com, request for an electronic manual.

CXW-210-A520(600)

CXW-210-A520(900)

吸油烟机

Range Hood

CONTENTS

Safety Precaution.....	1
Important Information.....	4
Product Overview.....	5
Packing List.....	5
Installation.....	6
Use Instruction.....	9
Maintenance and Services.....	10
Parts Removal.....	11
Circuit Diagram.....	13
General Troubleshooting.....	13

Dear users:



Thank for your buying our range hood. Please accept our best regards. Please read this user manual carefully before installation and operation.

*The pictures in this manual only for your reference. If the picture isn't accord with object, subject to object. We keep to right to update appearance, structure or products without notice.

Safety Precaution

In order to avoid harm or property damage to the users or other person, the following distinction and marks are stipulated. They are important safety precaution, please comply strictly based on the full understanding.

Subject to harmful or destruct degree







 Danger	If ignore this sign and operate product improperly, it's highly possible to cause danger, serious injury or fire.
 Warning	If ignore this sign and operate product improperly, it's possible to cause danger, serious injury or fire.
 Notice	If ignore this sign and operate product improperly, it's possible to cause injury or loss.

Notice and Prohibit Mark

 Prohibit	 Prohibit Flame	 Prohibit Touch	 Prohibit Touch by Wet Hand	 Prohibit Disassembly	 Strict Execution	 Necessary Earthed	 Caution Electric Shock	 Caution Scald
---	--	--	--	--	--	--	--	---

 Warning Please use this product according to manual strictly, or ROBAM shall not take any responsible caused by improper operation.

Danger

 Prohibit	Don't allow children or weakling to use range hood separately, or it may cause electric shock or other accident.
 Prohibit	Prohibit water on motor, switches or other electric parts; Prohibit wash range hood by water spray. Don't use range hood if wet or it may cause electric leakage or shock.
 Prohibit	Don't change, stretch, bind or press electric wire, or it's possible to cause electric shock or fire because of broken wire.
 Prohibit	Prohibit any change of interior circuit, or it may cause injury or other danger, for example, electric shock or fire.
 Prohibit Touch by Wet Hand	Don't touch plug, electric parts or button by wet hands, or it may cause electric shock.
 Strict Execution	Unplug before cleaning, installing or maintaining, avoiding from electric shock.

 **Danger**

Strict
Execution

Please turn off range hood immediately if pan got fire (range hood shall aggravate fire if it's working) and extinguish fire by effective action. For example, cover flame by metal cover, turn off gas valve immediately and remove inflammable things.

Strict
Execution

Any abnormal, please turn off power, take off plug or cut off electric source, and contact service. It's possible to cause electric shock or fire if using range hood under abnormal situation.

 **Warning**

Prohibit
Disassembly

Range hood must be installed, disassembled or maintained by professional person.

Prohibit

Stove fire shall be extinguished timely when it is not used; do not flambe under the range hood and it's prohibited to bake food under range hood directly to prevent range hood from damaging and causing accidents.

Prohibit
Touch

Don't touch bulb if it's on or just close in short time, or it may cause scald.

Strict
Execution

In order to ensure safety, range hood must be installed by specific accessory (especially expansion pipe and wooden screws, or it may cause accidental drop of range hood). The pipe bore and hole must fit tightly during the installation of metal expansion pipe. It is prohibited to make excessively large hole to prevent accidental drop of loosening expansion pipe.

Strict
Execution

The range hood must be used by specific plug and properly ground it. It's possible to cause electric shock, hot plug or fire because of improper electric wire. Installation must be executed by professional person based on local electrical regulations. Before connect electricity, power must be turned off.









Strict
Execution

If the supply cord is damaged, it must be replaced by the manufacturer, its service agent or similarly qualified persons in order to avoid a hazard.





Strict
Execution

All operation must comply with our safety guidelines as well as local safety regulations.







Warning

 Strict Execution	<p>There shall be adequate ventilation of the room when the range hood is used at the same time as appliances burning gas or other fuels.</p>
 Strict Execution	<p>This appliance just for household use only. And it's not allowed to exhaust dangerous or explosive matter or air. It should be put under dry and ventilation environment without dangerous air.</p>
 Strict Execution	<p>The range hood and electric circuit must be installed by skilled and trained personnel with required qualification. When installation, the related regulation, standard or instruction on fire must be complied. It may cause danger because of improper installation, for example, electric shock, drop or fire accident.</p>
 Strict Execution	<p>The outlet must be connect with outside. In order to ensure safety and fresh air, waste gas should be exhaust to outside. Don't exhaust waste gas to the wall, loft or garage.</p>
 Strict Execution	<p>There is a fire risk if cleaning is not carried out in accordance with the instructions.</p>
 Strict Execution	<p>Keep a good habit to turn off gas hob and gas valve if go outside, sleep or finish operation. Replace or check gas pipe regularly, since gas alarm device can't completely avoid accident caused by gas leakage.</p>
 Strict Execution	<p>This appliance is not intended for use by persons (including children) with reduced physical, sensory or mental capabilities, or lack of experience and knowledge, unless they have been given supervision or instruction concerning use of the appliance by a person responsible for their safety. Children should be supervised to ensure that they do not play with the appliance.</p>

Notice

 Prohibit	<p>The air must not be discharged into a flue that is used for exhausting fumes from appliances burning gas or other fuels, the discharge of air must fulfill the requirements of local regulations.</p>
 Strict Execution	<p>Before removing range hood for installation, clean or maintenance, power must be cut off avoiding from electric shock. When installation, clean or maintenance, protective gloove must be wear avoiding from injury.</p>
 Strict Execution	<p>The temperature for range hood working can't exceed 40°C.</p>

Notice

 Strict Execution	<p>Because the installation is difficult and hood is heavy, the installation shall be executed by professional person based on manual.</p>
 Strict Execution	<p>Don't break electric wire or other invisible equipment when cutting something or drilling holes on ceiling.</p>
 Strict Execution	<p>When range hood is using in well sealed building, it should have air inlet or open door to ensure good ventilation.</p>
 Strict Execution	<p>When the oil exceeds 2/3 or near tick mark in the oil cup, clean it in time. Don't eat waste oil from oil cup.</p>
 Strict Execution	<p>The wall of installing range hood needs enough strength. For hollow walls, the thickness of solid layer of hollow wall must be more than 30mm, but for concrete walls, it can be drill holes directly. The range hood must be fixed on the wall firmly.</p>
 Strict Execution	<p>Accessible parts may become hot when used with cooking appliances.</p>
	<p>DISPOSAL: Do not dispose this product as unsorted municipal waste. Collection of such waste separately for special treatment is necessary. This product must not be disposed together with the domestic waste. This product has to be disposed at an authorized place for recycling of electrical and electronic appliances.</p> <p>By collecting and recycling waste, you help save natural resources, and make sure the product is disposed in an environmental friendly and healthy way.</p>

Important Information

Package of Range Hood

Please settle those packages carefully in order to protect environment.

Don't allow children to play plastic film and package, it may cause asphyxia. Please avoid children near package material.

Before use Range hood

This range hood exhaust fume outside.

Please read this manual and all information carefully before installation and operation. Please comply with our suggestion. If it's necessary, please read manual for gas hob. And please keep these manual carefully for future reference.

If range hood has obvious damage, please don't electrify and contact operator.

Product Overview

Product Parameter

Model	CXW-210-A520(600/900)	Noise	≤56dB(A)
Power Supply	220-240V~ 50Hz	Rated Power Input	213W
Total Pressure Efficiency	≥18%	Rated Main Motor Power Input	210W
Nominal Wind Pressure	300Pa	Lamp Power(max)	2×1.5W
Max static pressure	450Pa	Dimension (L×W×H)	600(900)×290×290mm
Grease Absorption Factor	≥91%	Net Weight	CXW-210-A520(600) 9.5kg
Normal Odour Reduction Factor	≥98%		CXW-210-A520(900) 11.5kg

Note

1. The performance test results are all in 230V~50Hz power supply environment.
2. The tolerance between nominal wind pressure, max static pressure and actual data should be less than 10%.
3. The noise declared value shown is A weighted sound pressure level.

size&Dimension

Note1: the depth of cabinet must be more than 300 mm;

Note2: Labeled dimensions are only for reference. Size in the bracket is for A520(900).

(Unit: mm)

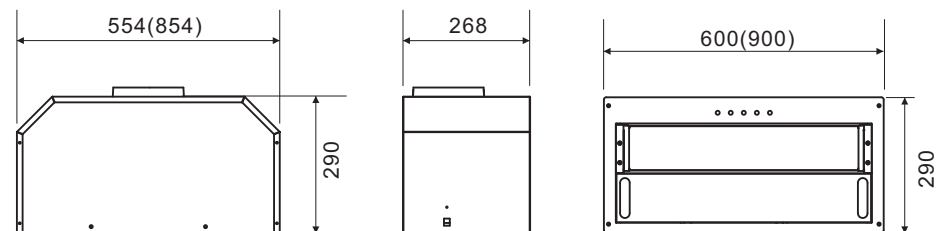

Packing List

Please check lists if open the package.

Packing List	No.	Name	Quantity	No.	Name	Quantity
	1	Range Hood	1 piece	2	Operation Manual	1 piece
	3	M4×30 countersink screw	4 pieces	4	Grey screw cap	4 pieces

Installation

Warning

- 1.The air must not be discharged into a flue that is used for exhausting fumes from appliances burning gas or other fuels, the discharge of air must fulfill the requirements of local regulations.
- 2.Note that when installing the metal expansion pipe, the pipe shall match with the hole in size. Overlarge hole is prohibited, as it will result in loose pipe and accidental drops.
- 3.There shall be adequate ventilation of the room when the range hood is used at the same time as appliances burning gas or other fuels.
- 4.If the flue aperture is less than air duct aperture, it will influence the fume suction effect and the too long air duct will influence the fume suction effect, too.
- 5.This appliance just for household use only.And it's not allowed to exhaust dangerous or explosive matter or air. It should be put under dry and ventilation environment without dangerous air.

Preparation Before Installation

●Surrounding environment

Range hood shall be avoided to be installed at the place where there are many doors and windows since it will cause too large cross-ventilation so as to influence the oil fume exhaust effect.

●Tool preparation

The following tools shall be prepared when range hood installation: 1. Electric impact drill (with drill); 2.Wrench; 3.Screw driver; 4.Ruler

Installation Notice

- Installation and circuit setting must be operated by professionals with experiences and non-professionals shall not assemble, disassemble and repair range hood.
- Don't connect power before installation, it may cause electric shock.
- If your kitchen is in decoration state, please do not expose the range hood outside since construction material, dust, paint, coating and the gases they volatile will corrode the surface of range hood and the surface will be tarnished. Therefore, it's suggested to assemble the range hood after decoration.
- If gas hob needs to be removed before installing range hood, please turn off gas valve firstly.
- Don't install range hood on the wooden or other flammable wall. The wall of installation range hood shall be on the nonflammable, enough stable, smooth and level surface.
- Range hood may have very sharp edge, please wear protective gloves while moving the range hood for installation, cleaning or maintenance.
- When drilling holes on the wall, the electric wire buried in the wall shall be avoided to prevent from fire.
- Range hood shall not be installed too high, nor shall it be disturbed by external air flow so that the fume suction effect will not be influenced.
- Please retain installation space for hood while fabricating cupboard so as for the care and maintenance .
- Please keep the hood body level while installing the machine.
- Please use single phase socket with earthing, which shall be well earthed.(Water pipe grounding is not reliable.The grounding of gas piping may cause the danger of fire and explosion.)
- Use appointed accessories for installation or range hood may fall down and cause danger.
- If the supply cord is damaged, it must be replaced by the manufacturer, its service agent or similarly qualified persons in order to avoid a hazard. Don't stretch, change ,tie, or press supply cord, or it may cause fire or electric shock.
- If finish installation, clean range hood firstly, then connect power and test run.

Installation

⚠ The hood shall be installed right above the hob. The minimum distance between the bearing surface of cooking appliance and the lowest part of hood is 650mm (larger space specified in the installation instruction of gas hob shall be considered, if any; the distance for electric cooker may be reduced appropriately, depending on the actual situations).
 Note: All data units of the following diagram are expressed in mm.

Figure 1

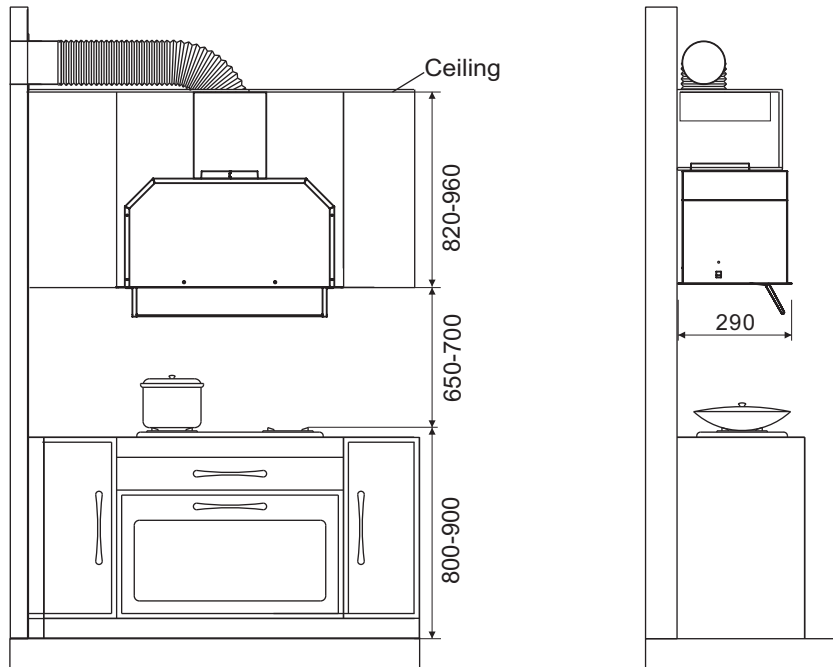
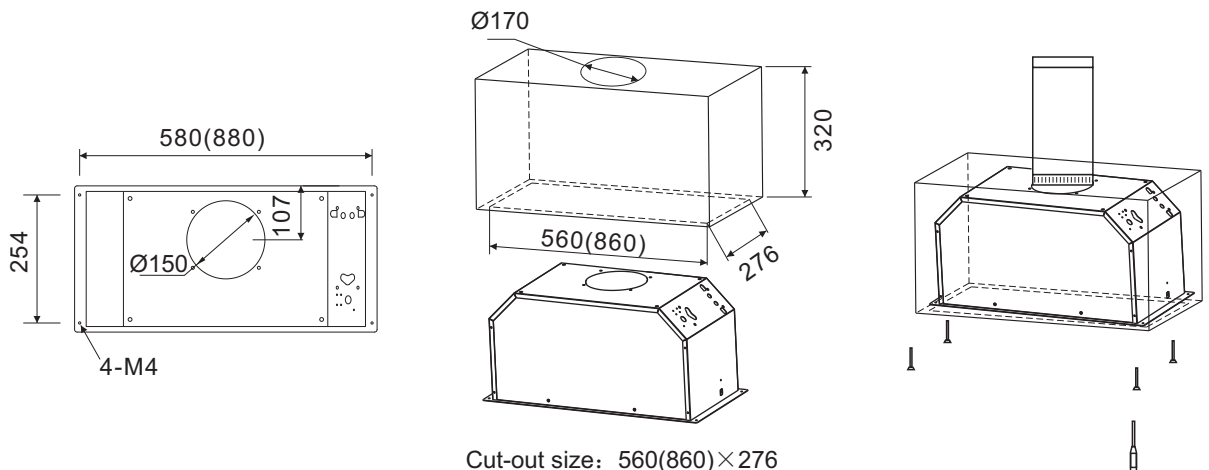

Figure 2



● Install the hood body(Fixing to the ceiling cabinet)

- Cut a hole in the cabinet as Figure 2, hole size: 560(860)x276mm. The hole should be centered on the bottom of cabinet.
- Before mounting the hood, plug in and test all functions for proper operation.
- Put the Fastening Ring (Optional) on one side of ALUM-NOD(Optional), and connect them onto the check valve outlet, then use screwdriver to fix the screw which is on the Fastening Ring, the ALUM-NOD is fixed on the check valve.(Figure 4)
- With assistance, hold the hood temporary in position ensuring the bottom is above the minimum clearance for the cooking surface. Mark on the cabinet the holes for the four mounting screws.
- Drill the holes at the distances indicated.
- Adjust the hood on appropriate position, secure unit by tightening screws. Then cover the screw caps on the screw holes.

Install Carbon Filter & ALUM-NOD (optional)

Figure 3

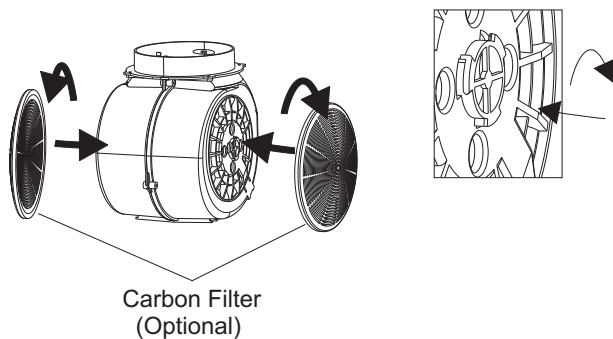
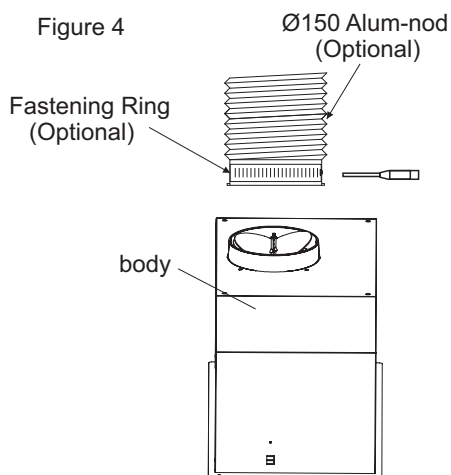

Figure 4



Note:

- Recyle mode - Carbon filter (optional) install: Put the carbon filter onto the motor fan system at two sides (Figure 3), then fix them in clockwise direction. Disassemble it vice-versa. It is suggested that the carbon filter should be replaced every 3 months in normal use.
- Please straighten the ALUM-NOD while assembling so as to prevent ALUM-NOD from producing noise at semi-stretching state.
- The diameter of exhaust wall hole shall be close to the air duct diameter, which shall not be too small, or it will cause unsmooth fume exhaust, rise of noise and reduction of airflow. Outlet pipe and wall hole or connection with public flue interface must be sealed strictly so as to make sure that the air duct and check valve or public flue interface are connected firmly and make sure that the blade of check valve or public flue interface is flexible in opening and closing.

Use Instruction

Switch Control Panel

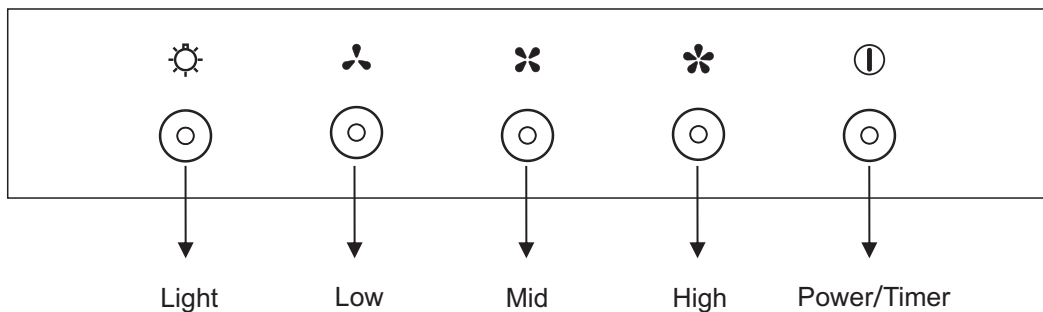

- Push “Power/Timer” button, the front glass will be opened automatically, then the motor will start running at “Low” speed (Indicating lights in “Power/Timer” and “Low” buttons are on).
- When the front glass is opening, push “Low” or “Mid” or “High” button, the motor will start running accordingly (Indicating lights in “Power/Timer” and “Low” or “Mid” or “High” buttons are on), push same speed button again, the motor will be off.
- When the motor is on working, push “Power/Timer” button, the motor will go to “Low” speed automatically, after 60seconds, the power (including the light) will be off.
- Push “Light” button, the light will be on (Indicating lights in “Power/Timer” and “light” buttons are on) . push “Light” button again, the light will be off.
- Push “Power/Timer” button 3seconds when the power is off, the front glass will be opened automatically for taking out the filter to clean. Push “Power/Timer” button 3 seconds again, the front glass will be closed.

⚠ Warning:

Do not open or close the front glass panel forcibly as it is controlled by motor automatically.

The back glass can only be opened when in cleaning, it must be taken off by manual with two hands carefully. Do not open it casually and forcibly.

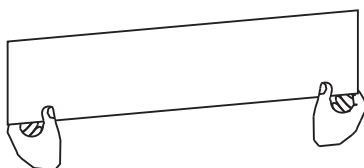

Maintenance and Services

Warning

1. There is a fire risk if cleaning is not carried out in accordance with the instructions.
2. Cleaning and maintenance shall be conducted under outage. Electrical components such as motor, switch, and connector shall not be spoiled by water so as to prevent from accidents.
3. It's prohibited to wash with water so as to prevent accidents.
4. Stove fire shall be extinguished timely when it is not used; do not flambe under the range hood and it's prohibited to bake food under range hood directly to prevent range hood from damaging and causing accidents.
5. If the supply cord is damaged, it must be replaced by the manufacturer, its service agent or similarly qualified persons in order to avoid a hazard.
6. Accessible parts may become hot when used with cooking appliances.

Notice

● The hood shall be cleaned and maintained regularly depending on the surroundings, so as to keep its cleanness & efficiency and extend its service life.

We recommend: Clean the surface of hood each time after cooking.

To ensure smooth discharge of fumes, the mesh cover shall be cleaned regularly with warm water and detergent according to actual situations. Be careful to avoid damage.

● Don't use the powerful detergent, we recommend to wipe with wet cloth soaked in neutral detergent and dry it by soft cloth. And avoid detergent to touch switches.

● Don't keep dirt on the surface of range hood for long time;

● Don't use cleaning ball, brush or other harsh tool to clean range hood. It may cause scoring.

● Wear gloves to clean or maintain range hood avoiding from hurt.

● Don't touch lamp if turn on or turn off in short time. It may cause scald.

● If range hood don't use for long time, pull out the plug. Don't haul plug crudely.

Parts Removal

⚠ Warning

1. The machine body needs not to be disassembled in ordinary conditions. Disassembly shall be operated by professional serviceman.
2. Before cleaning, installation or maintenance for the range hood, cut off the power supply to avoid electric shock.

Note: The assembly steps are opposite with the disassembly steps.
Please wear protective glove during operation avoiding from hurting hands.

Light Removal

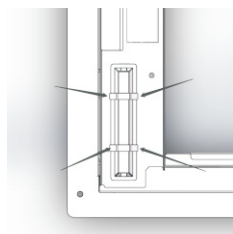

Remove the lamp cord terminal from the back of panel,
Press the spring as figure shown.

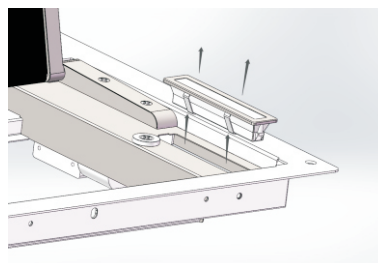

Push the LED out from the front of the panel
as figure shown.

Lamp image		Lamp information	
		Lamp Type	Rectangular LED
		Max Power	2×1.5W
		Voltage	12VDC
		Dimension	See the lamp image

Filter Mesh Removal

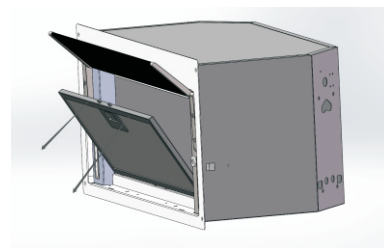
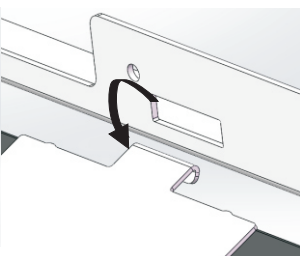
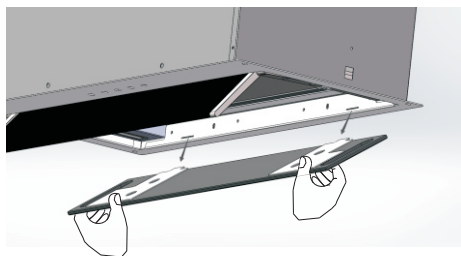

1. Push "Power/Timer" button 3 seconds, the front glass will be opened automatically.
2. Open the back glass panel which is magnetic suction carefully, remove slowly and place properly, take care not to impact the glass.
3. When you take down the back glass panel, you should use two hands to prevent the glass falling off.

3. Press the filter handle, and take out the filter as figure shown.

Switch Removal

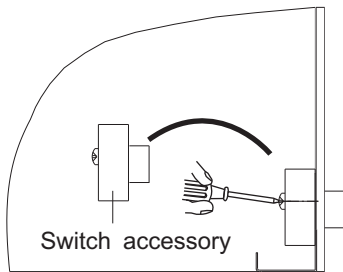

Unplug the terminals of wire group, then use a Philips screwdrivers to remove the two screws on the switch. Push the switch assembly to take it out for repair and replacement.

Removal Steps of DC motor

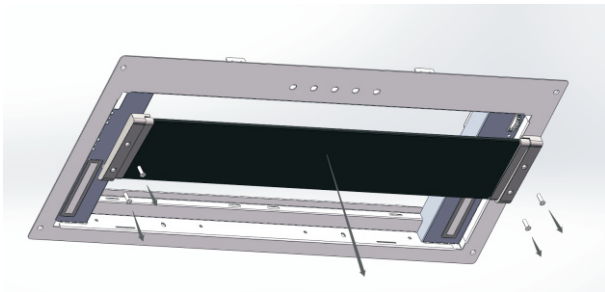

- 1.Remove 4 screws on the fixed plate of front glass;
- 2.Remove the front glass and fixed plate as figure shown, take care not to impact the glass.

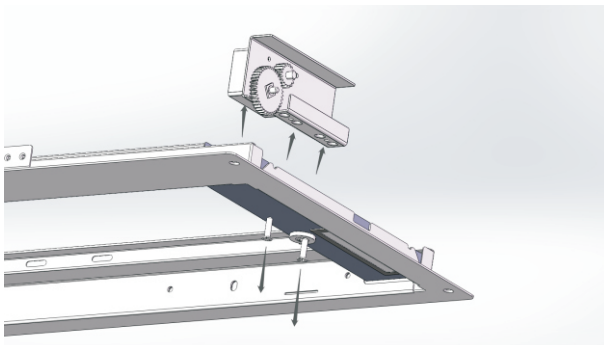

- 3.Remove 2 fixed screws;
- 4.Remove the DC motor assembly from the side of panel for repair and replacement.

Circuit Diagram

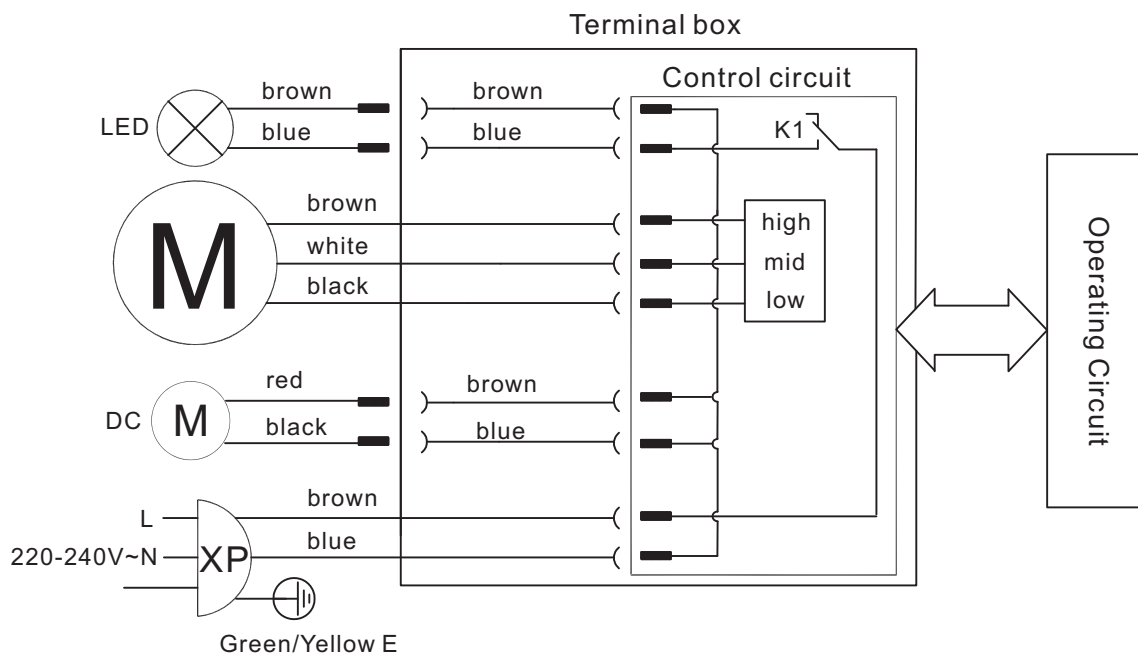

General Troubleshooting

No.	Fault Phenomenon	Fault Cause	Elimination Methods
1	No response by pressing any switch (e.g. impeller does not rotate, lighting lamp is not on)	Power plug is not well connected or power outage	Well connect the power plug
2	Press the lighting switch but the lighting is off	Lighting lamp is broken or power plug is not well connected	Replace lighting lamp or well connect the power plug
3	There is induced electricity on the surface of machine body, hand numbness	Power socket is not well grounded	Use single phase tripolar socket for well ground
4	abnormal sound when impeller is rotating	Impeller is loosened, set screw of impeller is not tightened	Tighten the set screw of impeller

目 录

安全注意事项.....	14
重要信息.....	16
产品简介.....	17
装箱单.....	17
安装说明.....	18
使用说明.....	21
维护与保养.....	22
部件拆卸.....	23
线路图.....	25
一般故障的排除.....	25

亲爱的用户

承蒙您的厚爱，购买了老板吸油烟机，借此机会，向您表示深深的谢意！

在使用本产品前，请您仔细阅读本说明书，并妥善保管，以备将来参考。



*本说明书中的图片为示意图，仅供参考，若图片与实物不符，以实物为准。本公司产品外观结构不断改进，对于产品改进所引起的内容更改，恕不另行通知。

安全注意事项

为了避免给使用者及其他人员造成危害或者财产损失，特作如下区分及标志。

以下均为有关安全的重要事项，敬请严格遵守，并在充分理解内容的基础上正确使用。

根据危害、损害程度进行的内容区分









 危险	若忽视这一标志，并进行错误操作，极有可能导致人员危险、重伤或引起火灾。
 警告	若忽视这一标志，并进行错误操作，有可能导致人员危险、重伤或引起火灾。
 注意	若忽视这一标志，并进行错误操作，有可能导致人员受伤或造成物品的损害。

注意、禁止内容的图标

 禁止	 禁止明火	 禁止触摸	 禁止用潮湿的手操作	 禁止拆卸	 严格执行	 需要接地	 当心触电	 小心烫伤
---	---	---	--	---	---	--	---	---

 **警告** 请严格按照本说明书规定使用，由于本产品使用不当造成的任何财产损失、人身伤害，本公司不承担责任。

危险

 禁止	请不要让无人监护的儿童及体弱者单独使用吸油烟机，否则有可能导致触电或其他意外伤害。
 禁止	严禁电机、开关、接插件等电器部件沾水；禁止用水冲洗吸油烟机。吸油烟机被水淋湿后，请不要使用；如果使用会导致漏电、触电等事故。
 禁止	请不要对电源线进行改制、拉伸、结扣以及施加重物、挤压等，否则易导致电源线破损而发生触电和火灾事故。
 禁止	禁止私自改动吸油烟机内部布线，否则有可能会发生异常动作导致人体受伤；修理不妥还可能发生触电、火灾等危险。
 禁止用潮湿的手操作	请不要用潮湿的手触摸电源插头、电器部件以及操作电源开关，否则易发生触电事故。
 严格执行	在清洗吸油烟机、提供安装或维修服务之前，必须切断电源，以免触电。
 严格执行	油锅着火时，请立即关闭吸油烟机（吸油烟机的运行会助燃火势），采用有效的灭火方法灭火。例如，用金属的盖子将明火盖住，立即关闭燃气总阀门，并使易燃物远离明火。
 严格执行	出现异常现象时，将电源开关按到停止状态，拔下电源插头或者切断总电源，马上与本公司当地售后服务中心联系。异常状态下连续运转易发生触电、火灾等危险。

警告



禁止拆卸

非专业人员请勿拆卸、安装及维修吸油烟机。



禁止

炉火在不使用时应及时熄灭，禁止炉火直接烘烤吸油烟机。禁止在吸油烟机下直接烧烤食物，以免损坏吸油烟机及发生意外。



禁止触摸

请勿触摸已经开启或者刚关闭不久的灯泡，以免烫伤。



严格执行

为确保安全和安装顺利，请使用随机附件进行安装（特别是膨胀管和木螺钉，必须使用随机附件，否则吸油烟机有掉下来的危险）；安装金属膨胀管时，管径与孔径的配合必须紧密，严禁钻孔过大，以免膨胀管松动，造成吸油烟机意外跌落。



严格执行

吸油烟机应使用专用电源插座，并且专用电源插座可靠接地；因电源线中途连接、使用延长线以及多口配线器时易发生触电、插头插座发热以及火灾。请确保由专业的电工来进行，并且要严格按照所有适用的国家和地方的电力法规；在接线以前，请先关闭电源并采取合理措施防止电源开关自动闭合。



严格执行

如果电源软线损坏，为了避免危险，必须由制造商、其维修部或类似部门的专业人员更换。



严格执行

遵照加热设备厂家的安全指南，同时要遵照消防等管理部门颁布的安全标准进行。



严格执行

当吸油烟机与燃烧燃气或其它燃料的炉灶同时使用时，房间必须通风良好。



严格执行

本产品仅供家庭日常使用，请不要在特殊环境中使用（例如：室外）；也不能用来排出有危险的或者容易爆炸的物质或者气体。产品在安装前应安放在干燥、通风、周围无腐蚀性及有害气体的环境中。



严格执行

吸油烟机的安装以及电路设置必须要由有经验的专业人员进行，非专业人员请勿安装。在安装时要遵守所有相关的法规、标准，包括与火灾有关的说明。用户自行安装易发生触电、脱落、起火等危险。



严格执行

出风管必须确保接到室外。为了避免火灾的发生并保持空气清新，请将废气排到室外。请不要将废气排到墙内、阁楼或车库中。



严格执行

如果不按说明书规定的方法清洗，吸油烟机有起火的危险。



严格执行

请养成外出、就寝或使用后及时关闭灶具开关按钮及燃气总阀门，定期更换、检查煤气管道的习惯，煤气泄漏报警装置不能完全避免煤气泄漏事故。



严格执行

器具不打算由存在肢体、感官或精神能力缺陷或缺少使用经验和知识的人（包括儿童）使用，除非有负责他们安全的人对他们进行与器具使用有关的监督或指导。应照看好儿童，确保他们不玩耍本器具。

⚠ 注意

	吸油烟机排出的气体不应排到用于排出燃烧燃气或其它燃料的烟雾使用的热烟道中。
禁止	
	在移动吸油烟机进行安装、清洁或者修理前，务必切断电源，以免触电；在进行安装、清洁或修理时，应佩戴防护手套，以防被吸油烟机内金属锐边伤手。
严格执行	
	吸油烟机使用的环境温度不能超过40℃。
严格执行	
	由于本吸油烟机的安装程序比较复杂，且重量较重，因此最好由专业安装维修人员按照说明书进行安装。
严格执行	
	当进行切割或者在墙壁房顶上或者天花板上钻孔时，请注意不要损坏电线以及其它隐藏设备。
严格执行	
	在密封性良好的建筑物中使用吸油烟机时，应保证有一空气入口，或将门稍打开一些，保证空气流通。
严格执行	
	当油杯内的积油超过三分之二或即将到达刻度线时，请及时清理，防止溢出。油杯中所收集的废油请勿食用。
严格执行	
	安装吸油烟机的墙壁要有足够的支撑强度，对于中空墙壁，中空板实心层的厚度必须大于30mm以上，对于混凝土墙壁可直接打安装孔。整机必须牢固安装在墙壁上。
严格执行	
	当使用烹饪器具时，易触及部件可能会发烫。
严格执行	
	处置：请勿将本产品作为未分类的城市垃圾处置。需要单独收集这些废物进行特殊处理。本产品不得与生活垃圾一起处理。本产品必须在授权的地方处理，以回收电气和电子设备。通过收集和回收废物，有助于节约自然资源，并确保产品以环保和健康的方式处理。

重要信息

吸油烟机的包装

请以环保的态度处置这些包装材料，以保持一个良好的环境。

请勿让儿童玩耍塑料薄膜和包装箱，这可能会产生窒息事故，所以请让包装材料远离儿童，包装材料不是玩具。

使用吸油烟机前

该吸油烟机的排烟方式是外排式。

在您着手安装和使用本产品前，请充分阅读此说明书及随机附带的各个文件，并严格遵守，必要时请同时阅读你所购买的灶具使用说明书，并将他们妥善保存好，以备将来参考。

如发现吸油烟机有明显的损坏，请勿通电，并立即与当地的经销商或服务中心联系。

产品简介

技术参数

型号	CXW-210-A520(600/900)	噪声	≤56dB(A)
电源	220-240V~ 50Hz	整机额定输入功率	213W
全压效率	≥18%	主电机额定输入功率	210W
标称风压	300Pa	照明灯最大输入功率	2×1.5W
最大静压	450Pa	外形尺寸(长×宽×高)	600(900)×290×290mm
油脂分离度	≥91%	主机净重	CXW-210-A520(600) 9.5kg
常态气味降低度	≥98%		CXW-210-A520(900) 11.5kg

- 注：1. 以上数据是在230V~50Hz测试环境下测得；
 2. 表中标称风压、最大静压的明示值与实测值误差小于10%；
 3. 所示噪声值为A计权声压级。

机体尺寸

注1: 橱柜深度尺寸必须大于300mm;

注2: 标注的尺寸仅供参考, 括号内的尺寸适用A520(900)。

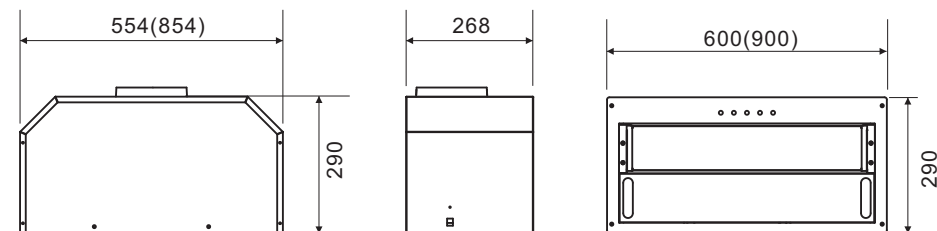

(单位: mm)

装箱单

开箱后请清点箱内物品

装箱单	序号	名称	数量	序号	名称	数量
	1	吸油烟机	1台	2	使用说明书	1份
3	M4×30 不锈钢沉头螺钉	4颗	4	灰色螺钉帽	4颗	

安装说明

警告

- 1.吸油烟机排出的气体不应排到用于排出燃烧煤气或其它燃料的烟雾使用的热烟道中。
- 2.安装金属膨胀管时，管径与孔径的配合必须紧密，严禁钻孔过大，以免膨胀管松动，造成吸油烟机意外跌落。
- 3.当吸油烟机与燃烧燃气或其它燃料的炉灶同时使用时，房间必须通风良好。
- 4.烟道口径小于风管口径会影响吸烟效果，风管过长也会影响吸烟效果。
- 5.本产品仅供家庭日常使用，请不要在特殊环境中使用(例如：室外)；也不能用来排出有危险的或者容易爆炸的物质或者气体。产品在安装前应安放在干燥、通风、周围无腐蚀性及有害气体的环境中。

安装前准备

●周围环境

吸油烟机应避免安装在门窗过多的地方，形成太大空气对流，而影响其除油排烟效果。

●工具准备

安装吸油烟机应准备以下工具： 1、冲击电钻（带钻头） 2、扳手 3、螺丝刀 4、尺

注意事项

- 吸油烟机的安装及电路设置必须由有经验的专业人员进行，只有经过专业培训的，并具有安装资质的人员，才能对吸油烟机进行安装，非专业人员请勿安装、拆卸及维修吸油烟机。
- 安装前请勿接通吸油烟机电源，以免触电。
- 如果您的厨房正处于装修状态，请勿将吸油烟机暴露在外，因为建筑材料、灰尘、油漆、涂料以及它们所挥发的气体，会使吸油烟机表面产生腐蚀和失去光泽。因此建议您在装修完毕后再安装吸油烟机。
- 如果在安装吸油烟机前，需要移动燃气灶，则在移动燃气灶前，请先关闭燃气总阀门。
- 请勿将吸油烟机安装在木质等易燃物的墙面上，安装吸油烟机的墙面应为有足够强度的不可燃物，且表面平直。
- 吸油烟机可能有非常锋利的边，在移动吸油烟机进行安装、清洁或修理时，请佩戴防护手套。
- 在墙壁或天花板等上面钻孔时，应避开墙内埋设的电线及其它隐藏设备，以免引起触电及火灾。
- 吸油烟机不要装得太高，也不要受外界气流干扰，以免降低吸烟效果。
- 制作橱柜时，请给机体留下装取空间，以利维护保养与检修。
- 装机时，请使机体保持水平。
- 请使用单相带接地插座，并良好接地（自来水管接地不可靠，煤气管道接地有引发火灾与爆炸的危险）。
- 为保证安全和安装顺利，请使用随机附件进行安装，否则吸油烟机可能会有掉下来的危险。
- 如电源软线损坏，为了避免危险，必须由制造商、其维修部或类似部门的专业人员更换。请不要对电源线进行改制、拉伸、结扣以及施加重物、挤压等，否则易导致电源线破损而发生触电和火灾等事故。
- 安装完毕后，请先对吸油烟机表面进行清洁，然后接通电源，进行试运行操作。

安装

⚠ 吸油烟机安装于炉灶正上方，炉灶上烹调器具的支承面与吸油烟机最低部位的最小距离为650mm（如煤气炉灶安装说明规定了较大的安装距离者，对此应予考虑。电灶可视实际情况适当降低）。

注：以下示意图的所有数据单位均以mm表示。

图1



图2



● 安装机体(固定在橱柜上)

- 在橱柜上开一个孔, 尺寸:560(860)x276mm, 如图2所示, 孔居于橱柜底部。
- 安装产品前, 请先插上插头, 测试所有功能是否正常。
- 将紧箍圈(选购)套在铝箔风管(选购)的一端, 再连接到止回阀接口外圈上, 用螺丝刀拧紧紧箍圈上的螺钉, 即可将风管固定在止回阀上。(见图4)
- 在助手协助下, 将烟机暂时固定在橱柜开孔的位置上, 确保底部高于烹饪表面的距离, 在橱柜上标记四个安装螺丝的孔位。
- 在标志的位置上钻孔。(见图2)
- 将烟机安装在箱体螺丝上, 并调整到适当的位置。烟机调整后, 用螺丝拧紧, 再装上螺钉帽封闭螺丝孔。

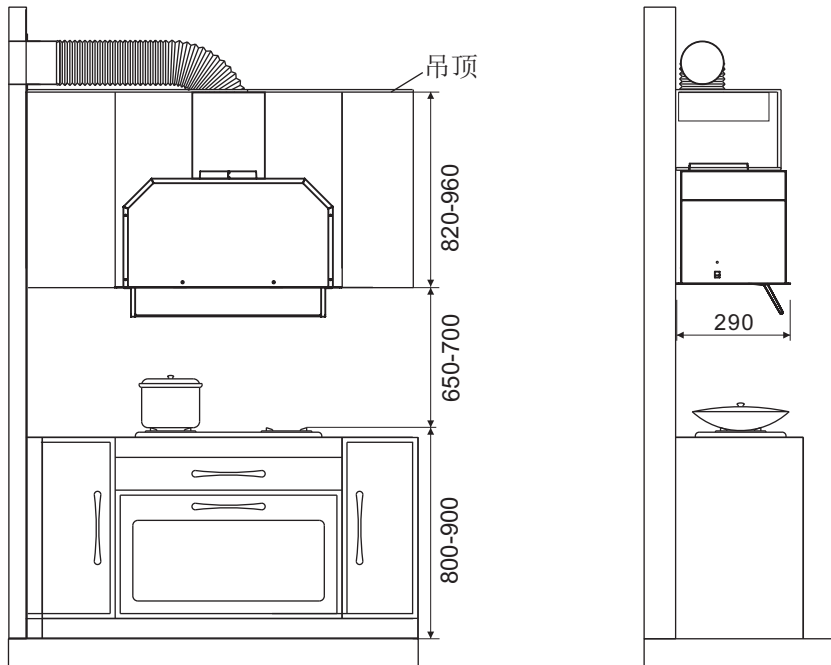
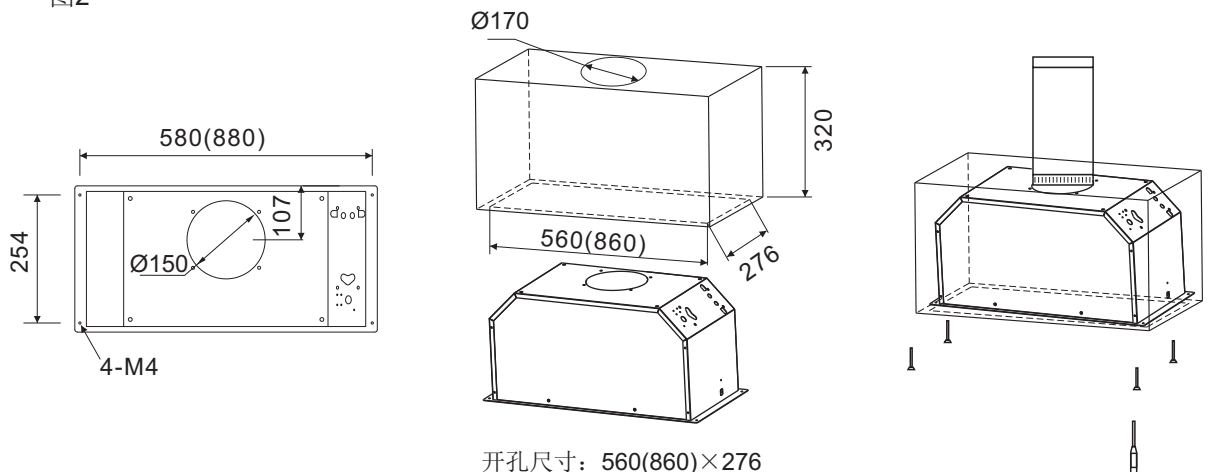
安装炭网和铝箔风管(选购)

图3



图4



注意:

- 内循环模式-活性炭网(选购)安装方式:将活性炭网对准风机系统两边顺时针拧入(见图3),反之拧出。
建议:活性炭网在正常使用状态下每3个月更换一次。
- 安装时请将铝箔风管拉直, 以免铝箔风管在半拉伸状态时产生噪音。
- 排风墙孔直径应与风管直径相近, 不应太小。否则会造成排烟不畅、噪音升高、风量降低等情况。出风管与墙孔或公共烟道接口连接处必须严格进行密封, 确保出风管与止回阀或公共烟道接口连接牢固, 必须保证止回阀或公共烟道接口处的叶片开合灵活。

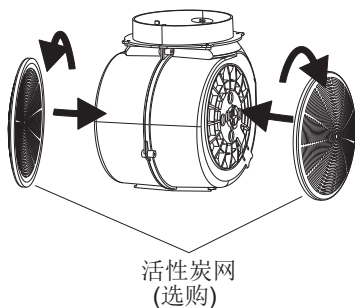
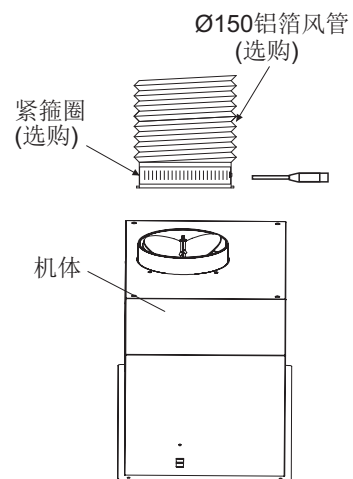
使用说明

开关控制面板

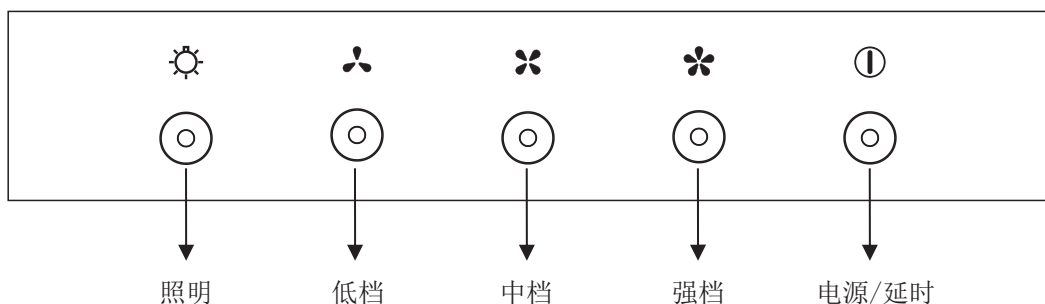

- 按“电源/延时”键，前玻璃板自动打开，电机“低档”档启动工作（“电源/延时”及“低档”按键上的指示灯亮）；
- 前玻璃板打开状态下，按“低档”或“中档”或“强档”键，电机会相应切换启动（“电源/延时”及对应的“低档”“中档”“强档”按键上的指示灯亮）。同一档位按键按两次，风机停止运行；
- 风机任意档位处于工作状态，按“电源/延时”键，风机自动切换到“低档”档，延时60S后，关闭一切工作（包括照明）；
- 按“照明”键一次，开启照明（“电源/延时”及“照明”按键上的指示灯点亮）。再按“照明”键一次，灯关闭照明；
- 在关机状态下长按3秒“电源/延时”键，前玻璃门自动打开，以方便取出滤网清洁。再次长按3秒“电源/延时”键退出清洁状态，前玻璃门关闭。

△ 警告：

前玻璃门由电机自动控制，请勿用蛮力打开或关闭前玻璃门。

清洁时，必须用双手小心取下后玻璃门。请勿随意或暴力取下该玻璃门。

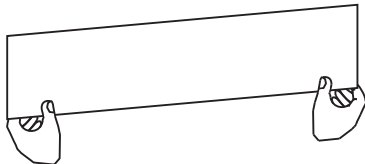

维护与保养

警告

1. 如果不按说明书规定的方法清洗，吸油烟机有起火的危险。
2. 清洗保养及维修工作必须在断电情况下进行，电器元件，如电机、开关、接插件请勿沾水，也不要潮湿的手触摸电源插头、电器部件及电源开关。
3. 禁止用水直接冲洗吸油烟机，以免发生意外。
4. 炉火在不使用时应及时熄灭，禁止炉火直接烘烤吸油烟机，禁止在吸油烟机下直接烧烤食物，以免损坏吸油烟机及发生意外。
5. 如果吸油烟机的电源线损坏，为了避免危险，必须由制造商、其维修部或类似部门的专业人员更换。
6. 当使用烹饪器具时，易触及部件可能会发烫。

注意事项

●吸油烟机应视环境条件定期维护清洗，以保持机体清洁与使用效果，延长使用寿命。

我们建议：产品外表面在每次烹饪后都进行擦拭。

为保证油烟顺畅排出，请定期对网罩进行清洗，洗时请小心，以免损坏。

●请勿用强力洗涤剂，建议用中性洗涤剂清洗，并用软布擦干。如果您的吸油烟机为机械开关，应同时避免清洁剂接触各控制键。

●不要让污渍在吸油烟机表面停留时间过长。

●请不要使用清洁球、刷子等粗糙物对吸油烟机进行清洁，以防止划伤机体表面。

●清洁或保养吸油烟机时，请戴上防护手套，以防擦拭过程中受伤。

●吸油烟机应在烹饪前开启。

●长期不使用时，请将电源插头拔出，但请勿用力拽拉。

部件拆卸

警告

1. 机体在一般情况下不需要拆卸，拆卸工作需由专业维修人员来完成，非专业人员请勿拆卸、安装及维修吸油烟机。
2. 在清洗吸油烟机、提供安装或维修服务之前，必须切断电源，以免触电。

注：以下部件的安装步骤与拆卸步骤相反。
为防止金属锐边伤手，请在操作时佩戴好防护手套。

灯拆卸

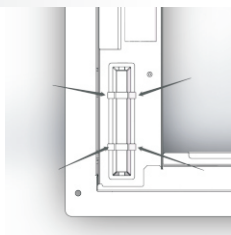

在面板背面拆卸灯线端子，
按图示按压弹簧片。

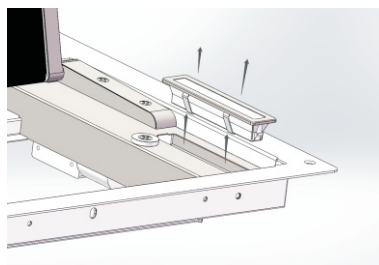

如图示在面板正面往外推出LED即可。

照明灯图形		照明灯信息	
		照明灯类型	长方形 LED
		最大功率	2×1.5W
		电压	12VDC
		尺寸	见照明灯图形

滤网拆卸

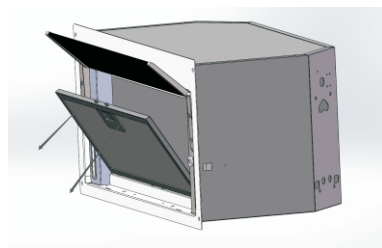
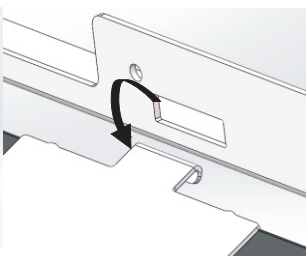
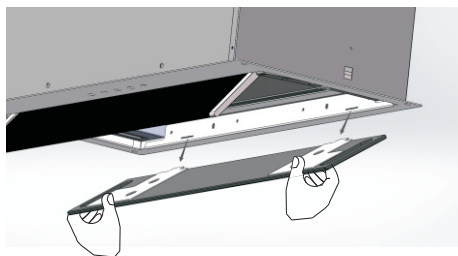

1. 长按3秒“电源/延时”键，前玻璃门自动打开；
2. 小心扒开磁吸后玻璃，如图所示从面板位置孔上掀出后玻璃，卸下来后放置妥当，避免碰撞玻璃；
3. 拆卸后玻璃时，需要双手扶持，慎防脱落。

3. 按压滤网把手位置，
按图示往外拿出滤网。

开关拆卸

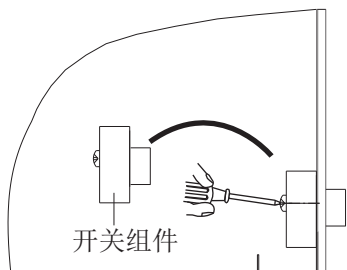

拔掉线组端子，用十字螺丝刀拧下开关上的两颗螺钉，往外移动开关组件即可取出，按需要进行维修更换。

同步电机拆卸

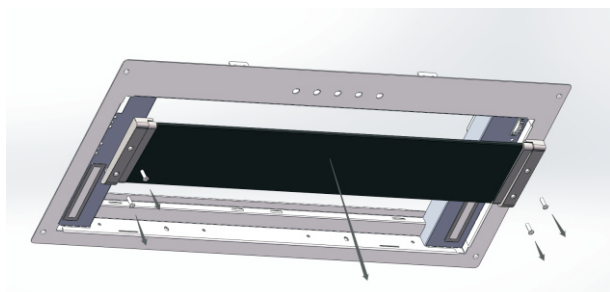

- 1、取下4颗前玻璃的固定板螺钉；
- 2、如图示固定板与前玻璃一同卸下来，注意避免碰撞；

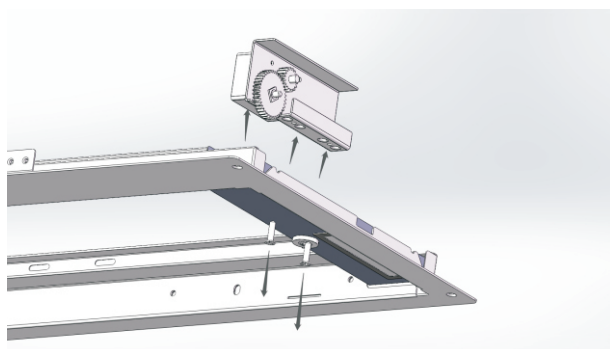

- 3、取下2颗固定螺钉；
- 4、面板背面可卸下同步电机组件，按需要进行维修或者更换零件。

线路图

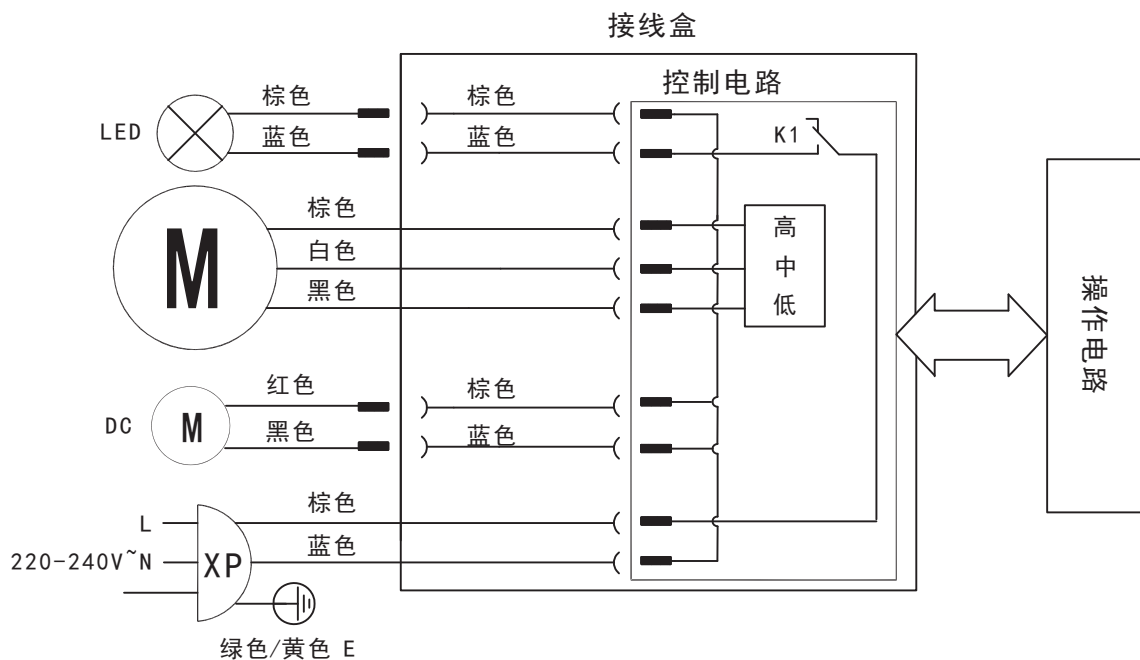

一般故障的排除

序号	故障现象	故障原因	排除方法
1	按任何键都无反应 (如叶轮不转动、照明灯不亮)	电源插头未插好或停电	插紧电源插头
2	按照明开关, 照明灯不亮	照明灯损坏或照明灯接触不良	更换照明灯或插紧电源插头
3	机体表面有感应电, 麻手	电源插座没有良好接地	使用单相三极插座 并良好接地
4	叶轮运转有异常声	叶轮或电机支架紧固螺丝松动	旋紧叶轮固定螺钉

版次: A/0

出版日期: 2020年3月24日

Edition: A/0

Publication Date: March,24,2020

ROBAM