

ROBAM



使用说明书 User Manual

如果说明书丢失，您可以发送电子邮件至overseas@robam.com，获取电子说明书。
If the manual is lost, you can send e-mail to overseas@robam.com, request for an electronic manual.

KZQC-40-CQ751

蒸烤一体机
Combi Steam Oven

Contents



Safety Precautions	1
Product Introduction	5
Installation Instructions	6
Operation Instructions	8
Maintenance and care	15
Common Faults and Fault Dropping	16
Electrical Schematic Diagram	17

Safety Precautions









In order to avoid any harm or property damage to the users and other persons, following distinctions and signs are specially given.

All these are the important notices concerned with safety, so please abide by these notices strictly. And, please use this product correctly on the premise that all the contents herein are understood fully.





Distinctions on contents made in accordance with extent of harm and damage

 Danger	Personal risk, serious injury or a fire may be very likely caused if this sign is neglected and the product is operated improperly.
 Warning	Personal risk, serious injury or a fire may be caused if this sign is neglected and the product is operated improperly.
 Notice	Personal injury or damage to objects may be caused if this sign is neglected and the product is operated improperly.

Signs of the behaviors that shall be paid attention to or that shall be prohibited

 Prohibited	 No open flames	 No touch	 No remove	 Abide by strictly	 To be grounded	 Electric shock danger	 Hot surface
---	---	---	--	--	--	--	--

 **Warning** Please use this product strictly in accordance with contents of this Operation Manual. Our company is not reliable for any property loss or personal injury caused by improper using of this product.

 Danger	
 Abide by strictly	Before disconnecting plug from the socket, you should grip the end of the plug. Be sure not to disconnect the plug with power wire in your hand, otherwise such dangers as electric shock, short out and fire may be caused .
 Prohibited	Be sure not to use a power socket which is loose or contacted poorly, otherwise such dangers as electric shock, short out and fire may be caused.
 Abide by strictly	Ensure that the appliance is switched off before replacing the lamp to avoid the possibility of electric shock.

 **Danger**

 **Abide by strictly** The complete appliance shall be kept far away from heat sources and inflammables (e.g. gas and alcohol).

 **Abide by strictly** If the surface is cracked, switch off the appliance to avoid the possibility of electric shock.

 **Hot surface** During use the appliance becomes hot. Care should be taken to avoid touching heating elements inside the oven. when taking out foods after using, make sure to wear the high-temperature resistant protective gloves properly in order to avoid burns.

 **Warning**

 **Abide by strictly** If the supply cord is damaged, it must be replaced by the manufacturer, its service agent or similarly qualified persons in order to avoid a hazard.

 **To be grounded** Use a separate **13A** or higher socket, and be sure not to connect several appliances to the same power socket at the same time, and make sure that the socket is grounded safely and effectively.

 **Abide by strictly** If the appliance functions improperly, make sure to disconnect it from the power and stop using immediately. And, be sure not to touch the appliance and that it is repaired by a professional.

 **Abide by strictly** Make sure the power cord is not damaged. When using the power cord, make sure that the cord is not bent, stretched, twisted or knotted. And, Be sure not to press or attack the power cord with weight.

 **Abide by strictly** In order project against fire, appliance must be kept in clean condition and the air passage must be kept unobstructed.

 Warning

Abide by strictly

Hot air may come out when door of the appliance is opened after using, so please be sure not to stand too close to the appliance to avoid burns caused by the hot air.

Abide by strictly

Accessible parts may become hot during use. Young children should be kept away.

Prohibited

This appliance is not intended for use by persons (including children) with reduced physical, sensory or mental capabilities, or lack of experience and knowledge, unless they have been given supervision or instruction concerning use of the appliance by a person responsible for their safety. Children should be supervised to ensure that they do not play with the appliance.

Prohibited

Do not use harsh abrasive cleaners or sharp metal scrapers to clean the oven door glass, since they can scratch the surface, which may result in shattering of the glass.

Prohibited

Do not place the flammable substance (such as the smoke agent) inside or under the steam oven. When the appliance is in operation, do not spray smoke agent near the oven. Do not use appliance unattended.

Abide by strictly

Disconnect the power supply when the appliance is not in use for long time.

Abide by strictly

Be sure not to operate the appliance when any of your hand or foot is wet or your feet are bare.

Abide by strictly

Improper use may result in water or gas leak. Contact the qualified service personnel for service.

 **Warning**

Abide by strictly

Turn off the appliance immediately after using, otherwise the residual fat may cause a fire; in case the appliance is not to be used for an extended period of time, please cut off the power.

Abide by strictly

Make sure to disconnect the electric oven from power before removing the fan guard. After cleaning, reset the guard properly to the original position in accordance with the Operation Manual.

Abide by strictly

You should cut off the power before cleaning of the appliance and use a neutral detergent to clean it. Moreover, make sure to clean it with a soft piece of cloth, in order to prevent its surface from being scratched.

 **Notice**

Abide by strictly

If the appliance functions abnormally, please disconnect the power plug and power it on again.

Abide by strictly

The internal grills and ovenware, etc. should be placed properly during using.

Prohibited

The appliance cannot be used as an indoor heater.

Abide by strictly

When the water in the drip tray is too excessive, adopt the absorbent cotton or cloth to absorb the water.

Prohibited

The steam cleaner is not to be used.

Prohibited

The appliance must not be installed behind a decorative door in order to avoid overheating.

Abide by strictly

This appliance just for household use only

Product introduction

Dear users:

We take this opportunity to express our heartfelt thanks to you for your choosing of ROBAM brand Combi Steam Oven series products. We especially recommend that you shall read this Manual carefully before installing and using this product and keep it properly for later reference.

The company is a professional manufacturer of household appliances and kitchenware such as range hoods, all-in-one steaming and baking machines, gas stoves, disinfection cabinets, electric ovens, etc. The boss brand all-in-one steaming and baking machine adopts advanced design concept, paying attention to overall design and optimizing modeling. It has the advantages of health, environmental protection, energy saving, etc.

This appliance is accounted as class I utensil. It must be grounded when in use.

※The pictures of the products in this manual are for reference only, and the products are subject to the actual objects. The company's products continue to improve, and changes in content due to product improvement will be made without prior notice.

Important Information

Packaging of Combi steam oven

Please dispose these packaging materials in an environment-friendly way, in order to keep a good environment.

Be sure not to allow children to play with the packaging materials (e.g. plastic film and carton box, etc.), otherwise it would lead to suffocation accident. So, please keep children away from the packaging materials.

Product Characteristics

- Set steam box and oven in one, delicious cooking more diverse;
- Steam is added in the baking process, the meat is tender and juicy, the European bread is crisp on the outside and soft on the inside;
- Steam at high temperature, quickly lock nutrition and cook food quickly;
- Double temperature and double control technology, precise temperature control, color, aroma and taste;
- Steaming and baking multi-stage combined cooking function subverts the traditional cooking method and gives a new experience;
- TFT touch color screen, easy to operate, easy to experience, enjoy high-end;
- An electric water tank is arranged on the top, water can be easily added without unpacking, and delicious taste is uninterrupted;
- Cleaning and maintenance function, clean and worry-free, cooking peace of mind.

Product Structure

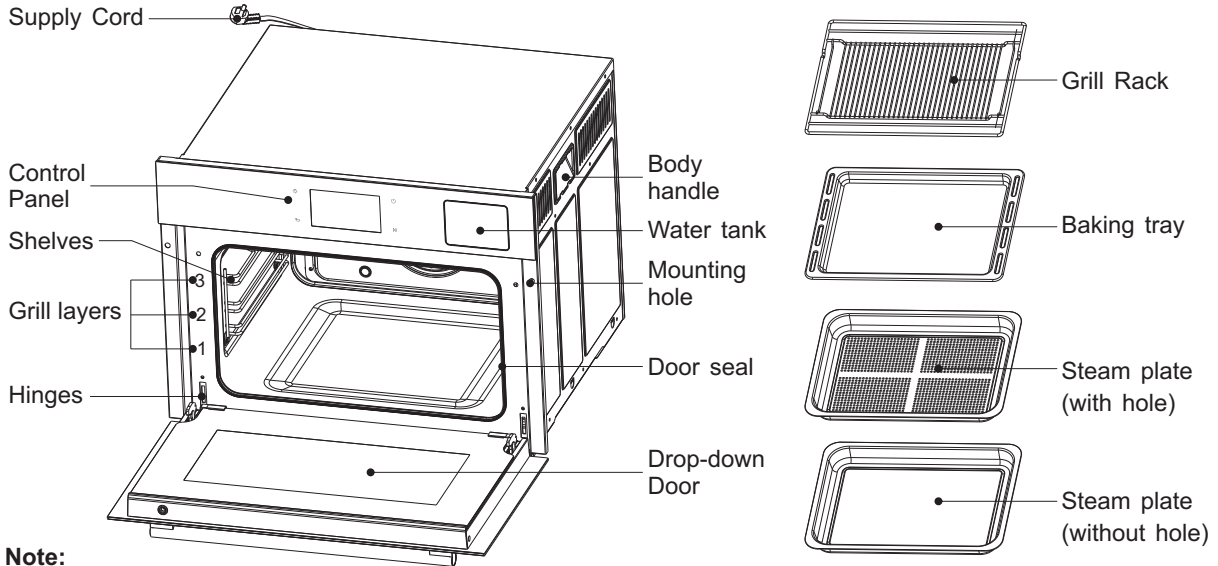

Note:

- The baking tray cannot be used under the steaming function.
- The steam plate cannot be used under the baking function.
- according to your cooking demand, place the steam plate, baking tray or grill rackflat on rail 1, 2 or 3, and push it to the end.

Technical Parameters of the Product

Model	KZQC-40-CQ751
Rated Voltage	220-240V~
Rated Frequency	50-60Hz
Rated Power	2400W
Capacity	40L
Net Weight	37.3kg
Dimensions(mm) W × H × D	595 × 455 × 520

※Wind baking as an energy efficiency testing mode.

List of Accessories

S/N	Name	Quantity
1	User Manual	1Pcs
2	Mounting screw	2Pcs
3	Baking tray	1Pcs
4	Grill Rack	1Pcs
5	Steam plate(with hole)	1Pcs
6	Steam plate(without hole)	1Pcs
7	Descaling Agent	1Pcs

Installation Instructions

Follow below illustration to set the square hole at the setting position of the cabinet. Insert the combi steam oven steadily into the square hole in place. Do not place the oven inclined. Detailed hole size (mm). refer to the below table:

S/N	Name	A	B	C
1	Dimensions of the hole for full insertion (W×H×D)	600	460	565
2	Dimensions of the hole for semi-insertion (W×H×D)	560	450	550

(The pictures are for reference only and the specifications are subject to the physical product)

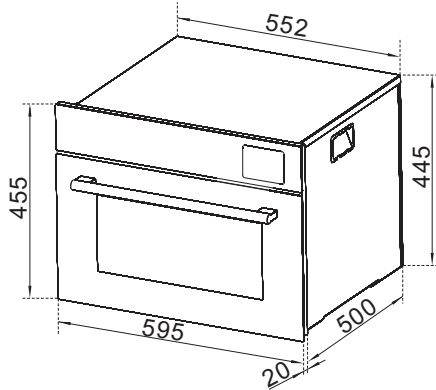

Complete dimensions diagram

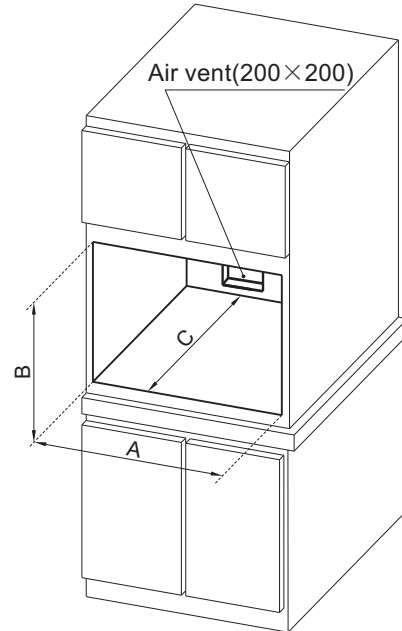

Semi-insertion hole diagram

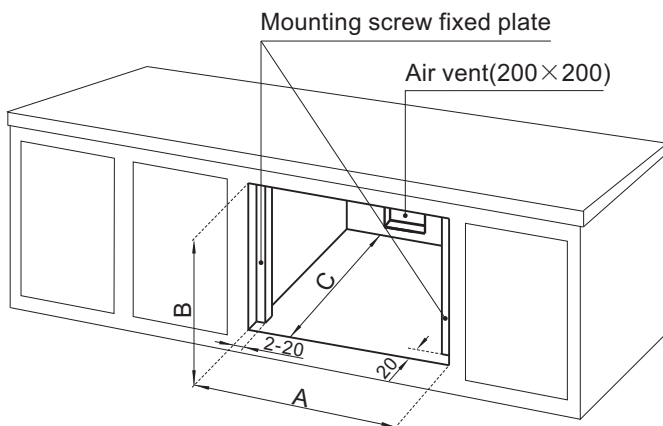

Full insertion hole diagram

Installation Requirements:

- The cabinet surface or table top to place the combi steam oven must be flat.
- Make sure the air circulation as much as possible around the steam oven inside the cabinet. Recommend the clamp plate and fixing plate to adopt the moisture proof, water proof, anti-corrosion and high temperature resistant material.
- Use the two mounting screws provided to fix the unit onto the cabinet through the mounting holes on the left & right door frames.

Power Supply Requirements:

- For permanent installation, the electrical circuit must have the disconnecting and protecting device. The power connection plug and outlet should be of the same model and compliant with the local regulations.
- The power plug connection must be convenient. Make sure the steam oven can be disconnected as necessary from time to time after installation. Separately use the socket of 13A or above. Do not use the same socket together with other electric appliance. Make sure the socket is securely and effectively grounded.
- If any other electric appliance nearby, make sure the installation distance is more than 100mm.

Operation Instructions

All interface diagrams in the following instruction manual are for reference only. The actual screen and APP interface shall be subject to the latest version.

Introduction to Control Panel

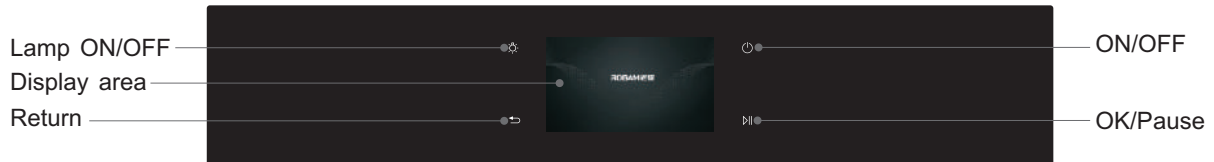

ON/OFF

Hold the key to shut down or turn on.

OK/Pause

Press this key to start when function was set, the screen will displayed as screen saver, touch the screen to active the screen. Press this key to pause while programme is running.

Return

Press this key to return to the last page or home page, this page will pop up when programme is running.

Lamp ON/OFF

press this key to turn the light on and off when energized. If not, the light will automatically turned off after few minutes.

Pre-use instructions

● When the product is used for the first time, peculiar smell will be emitted, which is caused by the coating protection of the heating element during storage and evaporation of the coating after heating. Therefore, the room should be kept ventilated, the high-temperature steaming function should be selected, the highest temperature and the longest working time should be set, and the work should be carried out without food. After the work is finished, the moisture in the product should be dried by using the drying function to ensure the delicious degree of subsequent cooking.

● **Water tank filling and installation precautions:**

1. When the appliance is on, press the “” icon to pop out the water tank. Take out the tank (see the illustration);
2. Check if the water tank is clean before use. If any abnormal odor or dirt, clean the tank accordingly. Do not use boiled water for clean;
3. Open the tank lid to fill water, and the amount of water added must not exceed the maximum water level line;
4. Push the tank filled with water into the tank trough. After the water tank is pushed into position, there will be a beep sound to notice you.

Note:

- It is forbidden to add hot water into the water tank to avoid deformation of the water tank and damage to the machine;
- When there is water shortage, the display screen will display an alarm page of “water shortage in water tank”;
- All use steam function or humidification function, after shutdown, the water pump starts to recycle the residual water.

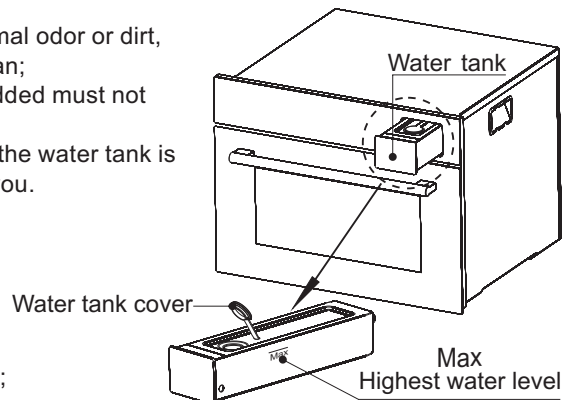

Warm Tip: When using the product, it is recommended that you turn on the range hood.

Using Methods

- 1. Power on** When the power supply is turned on for the first time, a prompt tone is issued, and the startup page is displayed on the display.



Note: In the shutdown state, press the “⏻” key to power on.

2. Choose a cooking method

Steaming Steaming function

- ① Click the “steaming” icon on the first page, and the display screen will enter the steaming function setting page;
- ② Select mode;
- ③ Setting the required temperature and time;
- ④ When the settings are complete, press “▶||” key to start and automatically to enter the preheating mode. When the preheating temperature is reached, a prompt tone will be issued. Press “▶||” key to pause. At this point, put the food into the cavity and press “▶||” key to activate, and when the cooking is completed, the buzzer will sound to prompt.

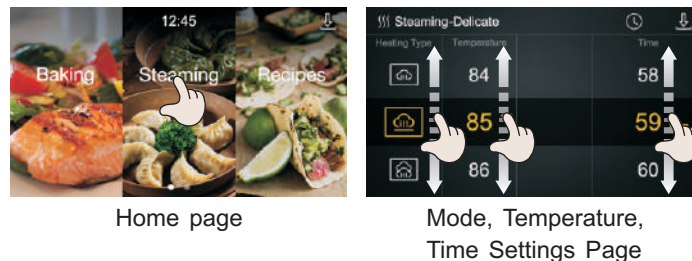

Note: After cooking with steaming function, it is recommended to dry the inner cavity or use drying function to dry.

Baking Baking function

- ① Click the “baking” icon on the first page, and the display screen will enter the baking function setting page.
- ② Select mode;
- ③ ~~Setting~~ the required temperature and time;
- ④ When the settings are complete, press “▶||” key to start and automatically to enter the preheating mode. When the preheating temperature is reached, a prompt tone will be issued. At this point, put the food into the cavity and when the cooking is completed, the buzzer will sound to prompt.

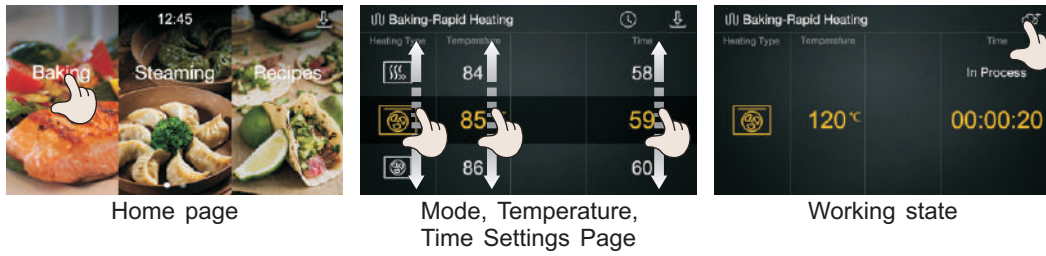

Note: ● in the working state, press “” in the upper right corner of the display screen. This function only lasts for one minute and stops adding steam after one minute. If you want to continue add steam, press “” icon again.
 ● The steam humidification function cannot be used for 2 minutes before the end of the work.

Recipes Recipes function

- ① Click the recipes icon on the first page, and the display screen will enter the menu setting page.
- ② Select recipes category;
- ③ Choose recipe;
- ④ Set the required time;
- ⑤ When the settings are complete, press “>||” key to start and automatically to enter the preheating mode. When the preheating temperature is reached, a prompt tone will be issued. Press “>||” key to pause. At this point, put the food into the cavity and press “>||” key to activate, and when the cooking is completed, the buzzer will sound to prompt.



Click this icon to view the cooking details (food materials, food preparation, tools)

Note: In the recipes setting page, the adjustment of specifications and time bar is different due to different recipes. Some dishes cannot be adjusted in specifications and time. Please refer to the actual display of products.

Multi Stage Cook **Multi Stage Cook function**

In order to satisfy the diversified taste of users, a multi-stage function is specially designed, which can set up three different ways to cook food.

- ① Click the “multi stage cook” icon in the home page, the display screen will enter the multi-segment cooking selection page, and click “1” the first icon to enter the mode, temperature and time setting page, and then click “▷||” key, confirm the first cooking mode;
- ② Click “2” the second icon to enter the mode, temperature and time setting page, and then click “▷||” key, confirm the second cooking mode;
- ③ Click “3” the third icon to enter the page of setting mode, temperature and time , and then click “▷||” key, confirm the third cooking mode;
- ④ After all three cooking methods are set, press “▷||” key to start, and when the preheating temperature is reached, a prompt tone will be issued, and press “▷||” key to pause. at this time, open the door and put the food into the inner cavity, then press “▷||” key to start. when the work is finished, the buzzer will sound to prompt.

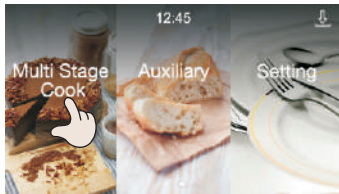

Home page

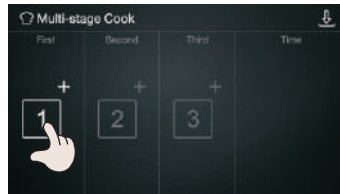

Multi-stage cooking selection page



Mode, Temperature, Time Settings Page

Note: This function requires at least two cooking modes to start the function.

Auxiliary **Auxiliary function**

Click the “auxiliary” icon, and the display screen will enter the corresponding working page. Customers can select the corresponding functions according to their needs. After the selection is completed, press the “▷||” key to start. When the selection is completed, the buzzer will sound and prompt.

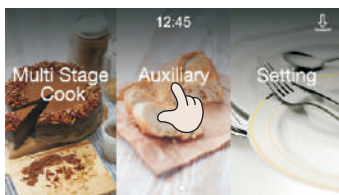

Home page

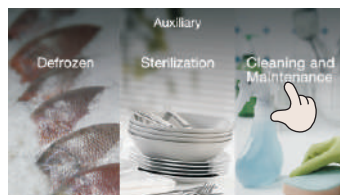

Auxiliary work page

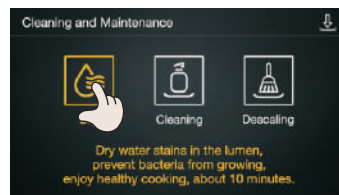

Select the appropriate function

- Note:**
- Cleaning and maintenance: includes three functions of drying, cleaning and descaling. Click the corresponding icon and press “▷||” key, the display screen has a corresponding prompt, the customer can operate according to it (note: this function cannot be suspended);
 - Descaling function: 30 grams of descaling agent shall be added before use, and the user will be reminded to descale after the accumulated working time is 50 hours (50 hours refers to the time will be restarted if the power is cut off in the middle under the condition that the product is not powered on, and it is recommended that the user descale after using the product for 50 hours);
 - Thawing function: temperature and time can be adjusted according to customer requirements;
 - Sterilization function: time and temperature are the default values and cannot be adjusted.

标红的这段，中文已经改过，请重新翻译下

除垢功能：使用前先添加30克除垢剂，工作时间累积50小时后会提醒用户进行除垢（50小时是指在产品不断电的工作情况下，若中间断电会重新开始计时，建议用户使用产品50小时后，进行除垢，在运行完除垢第一阶段后，除垢提醒即可清除并重新计时，但仍然建议用户完整执行完除垢的三个阶段。）；



Reservation function

For example: current time is 10:45am, users would like to start cooking at 11:30. Detailed operation steps are as follows:

- ① Firstly, choose the cooking method and set the cooking mode, temperature and time;
- ② Click “🕒” **Reservation** icon, enter the **reservation** time setting page;
- ③ Adjust the hour position to 11 and the minute position to 30;
- ④ Press “▶||” key to enter the reservation state;
- ⑤ After reaching the set time, enter the working state until the work is finished.

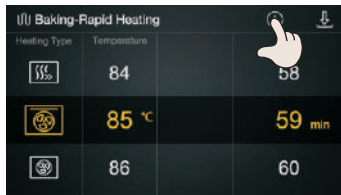

Mode, Temperature, Time Settings Page

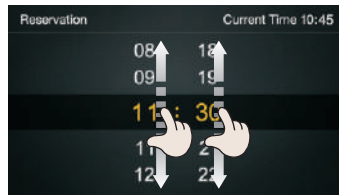

Appointment time setting page

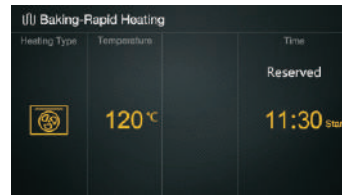

Reservation status

- Note:**
- For reservation, press “▶||” key to start working in the mode currently set;
 - Reservation time refers to local time when cooking starts;
 - Before using the reservation function, please ensure that the local time of the product is displayed accurately;
 - This function is not applicable to all modes. If “🕒” icon is displayed in the upper right corner, reservation settings can be made. Reservation settings cannot be made without this icon, please refer to the actual display of the product.

Setting Setting function

Time adjustment

- ① Click the “Settings” icon in the home page, and the display screen will enter the setting function page.
- ② Click “Time” to enter the time setting page and set the hours and minutes.
- ③ Press the “▶||” key to confirm after the setting is completed.

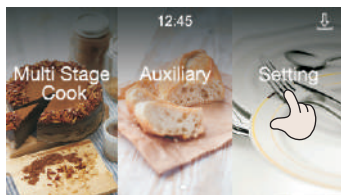

Home page

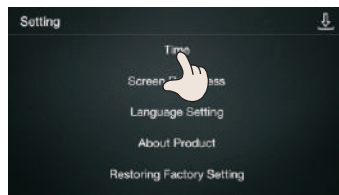

Setup function page

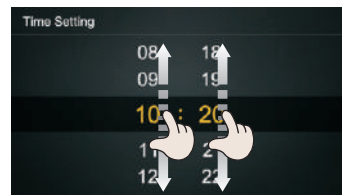

Time setting page

- Note:**
- When using the reservation function, the machine display time should be set to the same as local time, otherwise the reservation cooking start time will be affected.
 - Set the time to 24-hour clock.

Screen brightness adjustment

- ① Click the “Settings” icon in the home page, and the display screen will enter the setting function page.
- ② Click “Screen Brightness” to enter the brightness setting page, and press the “▶||” key to confirm after the setting is completed.

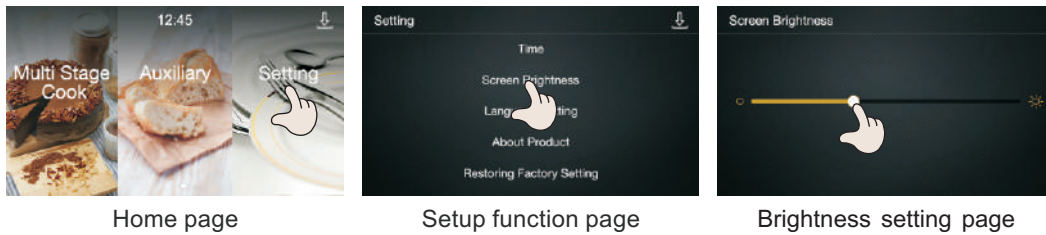

Home page

Setup function page

Brightness setting page

■ **About products**

- ① Click the “Settings” icon in the home page, and the display screen will enter the setting function page;
- ② Click the “about products” to display product information;
- ③ Click “↶” Key, return to the previous page.

■ **Restore factory settings**

- ① Click the “Settings” icon in the home page, and the display screen will enter the setting function page;
- ② Click “Restore Factory Settings” to enter the corresponding page and follow the prompts;
- ③ When finished, click the “↶” key to return to the previous page.

3. End of work

- ① After the work is finished, a prompt tone will be issued, and the display screen will display “finish” and “overtime” pages. Click “finish” to enter the home page or enter the shutdown state after a long period of no operation;
- ② If the customer wants to increase the cooking time, click the overtime icon to enter the overtime setting page, set the overtime (the maximum overtime time is 10 minutes), and press the “▶||” key after completion to continue working at the original mode and temperature; After finishing, return to the “finish” and “overtime” pages again;

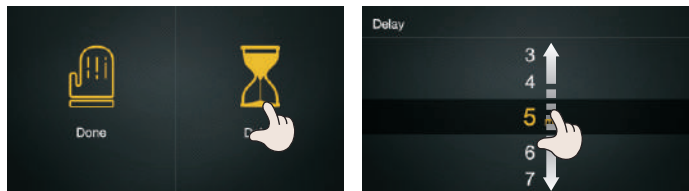

Complete, overtime page



Timeout Settings Page

- ③ Hold the “⏻” key to shut down the combi steam oven;
- ④ the combi steam oven will automatically shut down after long time standing by.

Note: ● If the internal temperature of the product is too high, the cooling air fan stop running after a period of delay, which is conducive to prolonging the service life of the machine.

- In order to shorten the heat dissipation time, it is recommended to open the product door during heat dissipation.
- After the multi-segment function is completed, the display only shows “done”.

Common Baking Symptoms and Remedies

Symptoms	Possible Causes	Remedies
Baking is uneven	<ul style="list-style-type: none"> * Position of the baking layer is incorrect * Foods are not placed at center part of the ovenware * Selected function is improper  	<ul style="list-style-type: none"> * Select an appropriate baking layer position * Place foods at center part of the ovenware * Select a proper function
Upper surface color or bottom color of the baked foods is dark 	<ul style="list-style-type: none"> * Selected function is improper * Size of foods is non-uniform or foods are not arranged evenly * Baking temperature is too high * Door of the electric oven is opened frequently during baking 	<ul style="list-style-type: none"> * Select a proper function * Cut foods into uniform pieces and arrange them evenly on the ovenware * Lower the temperature * Place the foods to a lower or higher position * Only open door of the electric oven when half of the baking time elapses
The baked cake has cracks or thick crust	<ul style="list-style-type: none"> * The baking time is too long * Baking temperature is too high * Bake recipe or preparation method is incorrect * Selected container is improper 	<ul style="list-style-type: none"> * Adjust the baking time * Lower the temperature * Adjust recipe and adopt correct preparation methods * Replace with a proper container
The baked foods are light-colored or under-baked	<ul style="list-style-type: none"> * Baking temperature is too low * Baking time is too short 	<ul style="list-style-type: none"> * Adjust the baking temperature * Extend the baking time

Heating mode

Function	Default working temperature (°C)	Default working time (min)	Temperature range (°C)	Time range (min)
Rapid Heating	200	30	50-230	1-120
Hot Air Baking	200	30	50-230	1-120
Baking	160	30	50-230	1-120
Bottom Heating	160	30	50-180	1-120
Fan Gril	220	30	50-230	1-120
Grillingl	180	30	50-230	1-120
Maximum Grill	180	30	50-230	1-120
EXP	Upper160 Lower140	20	100-200	1-120

Heating mode

Function	Default working temperature (°C)	Default working time (min)	Temperature range (°C)	Time range (min)
Fast Preheating	180	90	50-230	-
Frying	150	30	50-230	1-120
Warm	60	120	40-90	-
Dried Fruit/Vegetable	60	30	50-80	1-120
Defrozen	60	20	40-80	1-120
Tender	90	20	90-95	1-120
Delicate	100	20	96-105	1-120
Rich	120	20	106-150	1-120
Ferment	38	60	35-60	1-120

Note: According to the heating mode of this table, users can know the heating mode and select the appropriate baking function.

Maintenance and care

Important Notification: Before cleaning the steaming and baking machine, the power supply must be cut off.

The appliance must always be kept clean to ensure that there is no accumulation of fat and grease around the heating elements and fans; Baking pans and grills must be cleaned so as not to cause fire due to accumulation of fat. Meat can be wrapped in aluminum foil for cleaning during baking. Any fat and grease will form a layer of paint-like build-up layer in the appliance, which is difficult to clean, so it should be cleaned after each use.

1. Internal cavity: wash with warm water, do not use corrosive and abrasive cleaning agents. Stains that are difficult to remove can be cleaned with nylon brush or neutral detergent, and cannot be scrubbed with steel wire balls to avoid irreparable damage to the surface. The cleaning agent in the cavity must be cleaned without residue. After cleaning, wipe it with cloth to keep the cavity dry, or use the drying function to dry.

2. Glass panel: the glass surface on the door and control panel should be cleaned immediately when it is dirty. the firm dirt can be cleaned with neutral detergent and cannot be scrubbed with steel wire balls to avoid scratching the surface. wipe it dry with cloth after cleaning.

3. After each use, please take out the water tank and pour out the water so as not to generate peculiar smell over time.

4. After use, the accumulated water in the water collecting tank must be cleaned in time to prevent water from overflowing.

5. Remove and install the fan cover plate: the fan cover plate is fixed inside the cavity with 4 screws, and the fan cover plate can be removed by unscrewing the screws counterclockwise.

Note: The fan cover plate must be replaced after cleaning.

6. Dismantle and install the shelf (the left and right ① shelves are in the same way): press the position of the shelf (fig. 1) until the shelf leaves the set screw, and press the arrow (fig. 4) to take it out upward to remove it. Reinstall the shelf, press (Figure 2) to insert the alignment screws 1 and 2 at the lower end of the shelf, and then snap the upper end of the shelf into the set screws.

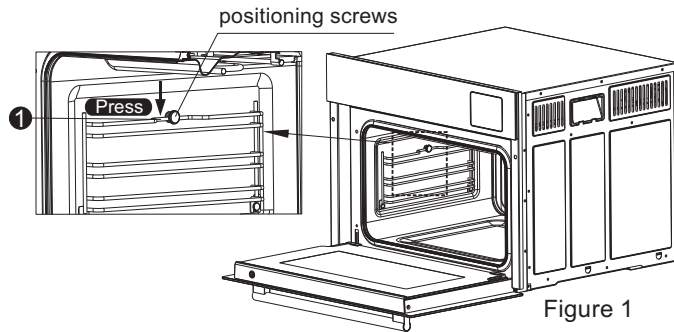

Figure 1

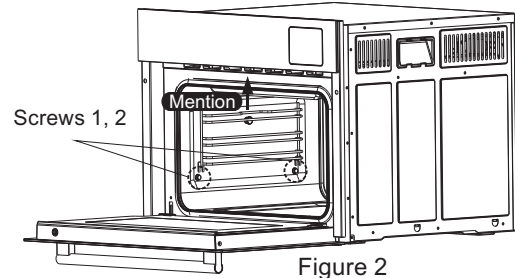
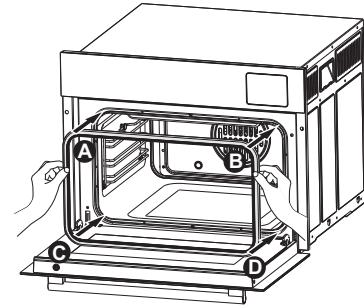

Figure 2

7. Pinch both hands to the left and right A and B semi-fillets on the upper edge of the door seal, align with the semi-filletted groove on the upper edge of the front plate, and press in firmly; Then align that left and right C and D semi-round corners at the low edge with the semi-round corner groove at the lower edge of the front plate, Press in with force; Then press the four edges into the groove completely respectively, and ensure that they are flat after pressing in. Door Whole, wrinkle-free, seamless.

Door seal Installation Instructions



Common Faults and Fault Dropping

The following table lists common faults. Please confirm and handle them according to the listed instructions. If the fault cannot be handled or the cause cannot be confirmed, please contact the local dealer or after-sales service center. For the sake of your safety, we specially remind you not to disassemble and repair it yourself.

Faults	Possible Causes	Fault Dropping
Can not work	Whether the power is cut off and the power plug is plugged in	Use after electrifying
The display is not bright	Power failure or computer board failure	Check the power supply or ask a professional to repair it
The lights are not on	Power failure or bulb failure	Check the power supply or ask a professional to repair it
There is leakage of air and water at work	The door is not tightly closed, the door seal is not in place or the door seal is damaged	Check the door closure, reinstall the door seal or contact professional maintenance personnel
The display shows "water tank is short of water"	The water tank is short of water or the water level detection switch and water pump fail	Add water or contact professional maintenance personnel
The temperature cannot rise	Failure of steam generator, computer board and temperature sensor	Please contact professional maintenance personnel

Failure phenomenon	Reason	processing method
A sudden black screen at work	Temperature controller protection, computer board failure	Please contact professional maintenance personnel
The water tank cannot be ejected	Push rod motor failure, computer board failure	Please contact professional maintenance personnel
Display screen display Temperature sensor failure in equipment	Temperature sensor failure, computer board failure	Please contact professional maintenance personnel
Display screen display Fan failure in equipment	Cooling fan failure, computer board failure	Please contact professional maintenance personnel
The display screen shows the communication failure in the equipment	Communication failure (abnormal connection of display board) and computer board failure	Please contact professional maintenance personnel

Warning: Please push the water tank into place before use.

Electrical Schematic Diagram

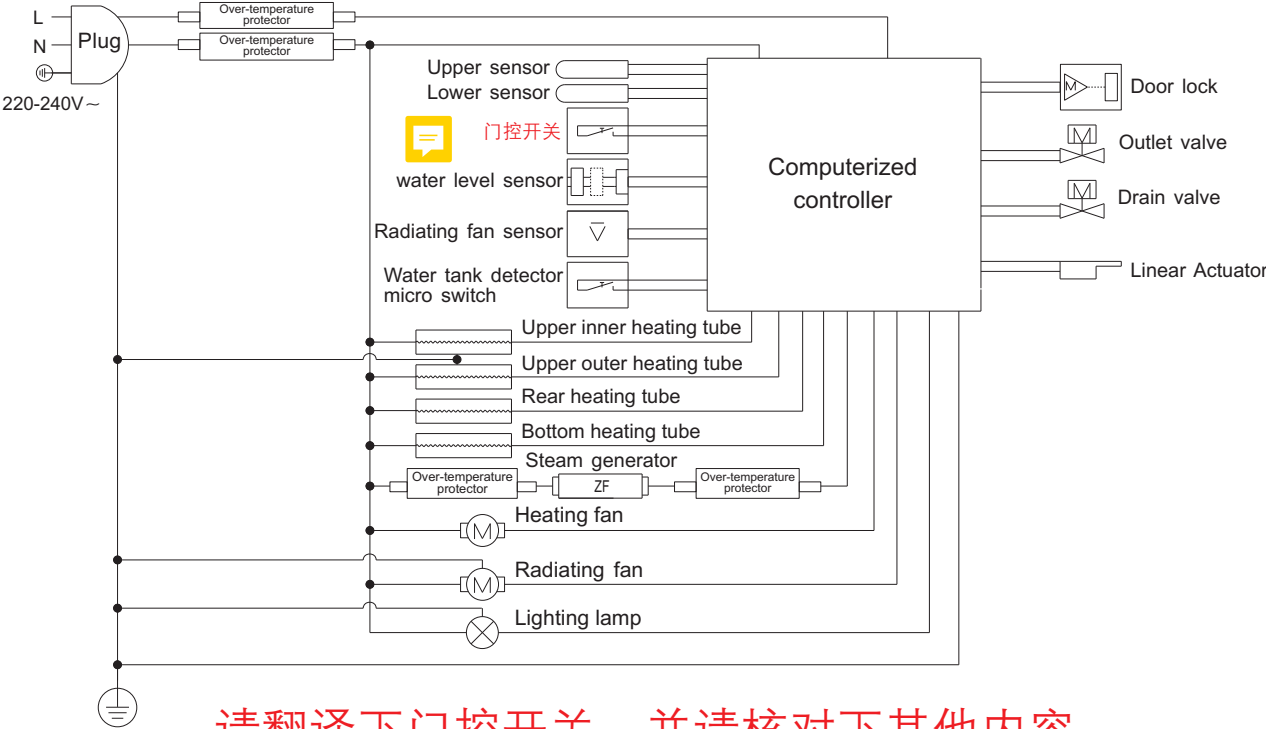



目 录

安全注意事项	1
产品简介	3
安装说明	5
使用说明	6
维护和保养	12
常见故障及处理方法	13
电气原理图	14

安全注意事项

为了避免给使用者及其他人员造成危害或者财产损失，特作如下区分及标志。
以下均为有关安全的重要事项，敬请严格遵守，并在充分理解内容的基础上正确使用。







根据危害、损害程度进行的内容区分

 危险	若忽视这一标志，并进行错误操作，极有可能导致人员危险、重伤或引起火灾。
 警告	若忽视这一标志，并进行错误操作，有可能导致人员危险、重伤或引起火灾。
 注意	若忽视这一标志，并进行错误操作，有可能导致人员受伤或造成物品的损害。









注意、禁止内容的图标









 禁止	 禁止明火	 禁止触摸	 禁止拆卸	 严格执行	 需要接地	 当心触电	 小心烫伤
---	---	---	---	---	--	---	---

 **警告** 请严格按照本说明书规定使用，由于本产品使用不当造成的任何财产损失、人身伤害，本公司不承担责任。

 危险	
 严格执行	拔出插座上的插头时，必须手握插头的端部将其拔出，请不要手拿电源线拔插头，否则易发生触电、短路、起火等危险。
 禁止	请不要使用松动或接触不良的电源插座，否则易导致触电、短路、起火等危险。
 严格执行	为避免可能出现的电击，换灯泡前应确定器具已断开电源。
 严格执行	整机远离热源，煤气和酒精等易燃物品。
 小心烫伤	器具在使用期间会发热，注意避免接触器具内的发热单元，以免烫伤和灼伤；工作结束后取出食物时务必戴好耐高温保护手套，以免烫伤。
 严格执行	如果该表面有裂纹，关掉器具以避免可能出现的电击。

 警告	
 严格执行	如果电源软线损坏，为了避免危险，必须由制造商、其维修部或类似部门的专业人员更换。
 需要接地	单独使用 13A 或以上的插座，请勿与几个电器同时使用同一个电源插座，并确保插座安全有效接地。
 严格执行	若器具出现故障请立即断开电源停止使用，并且不要触摸器具，请专业人员维修。
 严格执行	不得损伤电源线。使用电源线时不得折弯、拉伸、扭转、打结。不得用重物扣压、夹击电源线。

 警告	
 为防火警，器具必须保持清洁，风道必须畅通无阻。 严格执行	 蒸功能结束后，打开器具门时会有蒸汽喷出，不要正对器具开门方向，以免蒸汽烫伤。 严格执行
 器具在使用时可触及部分可能会发热，儿童应远离。 严格执行	 禁止无人照看的幼儿和残疾人使用此器具，并禁止儿童玩耍器具。 禁止
 勿使用强腐蚀性清洗剂或锋利的金属刮刀清洁器具的玻璃，因为其会擦伤玻璃表面，从而可能导致玻璃破碎。 禁止	 不可将易燃物质（例如烟雾剂）放置器具的里面和下面；使用器具时，不得在其附近喷洒烟雾剂，必须始终有人看管。 禁止
 器具长期不使用，应切断电源。 严格执行	 如使用不当会导致漏水、漏气现象，请专业维修人员维修。 严格执行
 请勿在手脚潮湿或赤脚的状态下操作器具。 严格执行	 移开风扇保护装置前必须将器具断电。清洁后，必须按使用说明把保护装置重新设置到原位置。 严格执行
 用好后立即关闭器具，否则残余的脂肪会引发火警。 严格执行	 清洗时必须切断电源，注意使用中性清洗剂。同时使用柔软抹布擦洗，防止划伤表面。 严格执行

 注意	
 若器具出现功能不正常时，请拔掉电源插头重新上电。 严格执行	 使用时内部烤架、烤盘等放置必须正确到位。 严格执行
 器具不能用作室内取暖器。 禁止	 当集水槽中水过多时，请使用抹布将水槽中积水吸干。 严格执行
 清洁保养的时候不能使用蒸汽清洁器。 禁止	 器具不能安装在装饰性门后面以免温度过高。 禁止
 本器具仅供家庭使用。 严格执行	

产品简介

亲爱的用户：

让我们借此机会，对于您购买了老板牌蒸烤一体机表示衷心的感谢。我们特别建议您在着手安装和使用本产品前，有必要仔细阅读此说明书，并请将其妥善保存，以备今后查阅。

本公司是国内生产吸油烟机、蒸烤一体机、燃气灶具、消毒柜、电烤箱等家用电器和厨具的专业企业；老板牌蒸烤一体机采用先进的设计理念，注重整体设计、优化造型；它具有健康、环保、节能等优点。

本产品属于I类器具，使用时必须具有可靠的接地。

※本说明书中的产品图片仅供参考，产品以实物为准。本公司产品持续改进，因产品改进所引起的内容变更，恕不另行通知。

重要信息

蒸烤一体机的包装

请以环保的态度处置这些包装材料，以保持一个良好的环境。

请勿让儿童玩耍塑料薄膜、纸箱等包装材料，这可能会产生窒息事故，所以请让包装材料远离儿童。

产品特点

- 集蒸箱、烤箱于一体，美味烹饪更多样；
- 烘烤过程添加蒸汽，肉类鲜嫩多汁，欧式面包外部焦脆，内部松软；
- 高温蒸，迅速锁住营养，快速烹饪食物；
- 双温双控技术，精准控温，色香味一应俱全；
- 蒸烤多段组合烹饪功能，颠覆传统烹饪方式，全新体验；
- TFT触摸彩屏，操作简单，轻松体验，尽享高端；
- 上置电动水箱，无需开箱即可轻松加水，美味不间断；
- 清洁保养功能，清洁省心、烹饪安心。

ROBAM老板 | 蒸烤一体机

产品结构

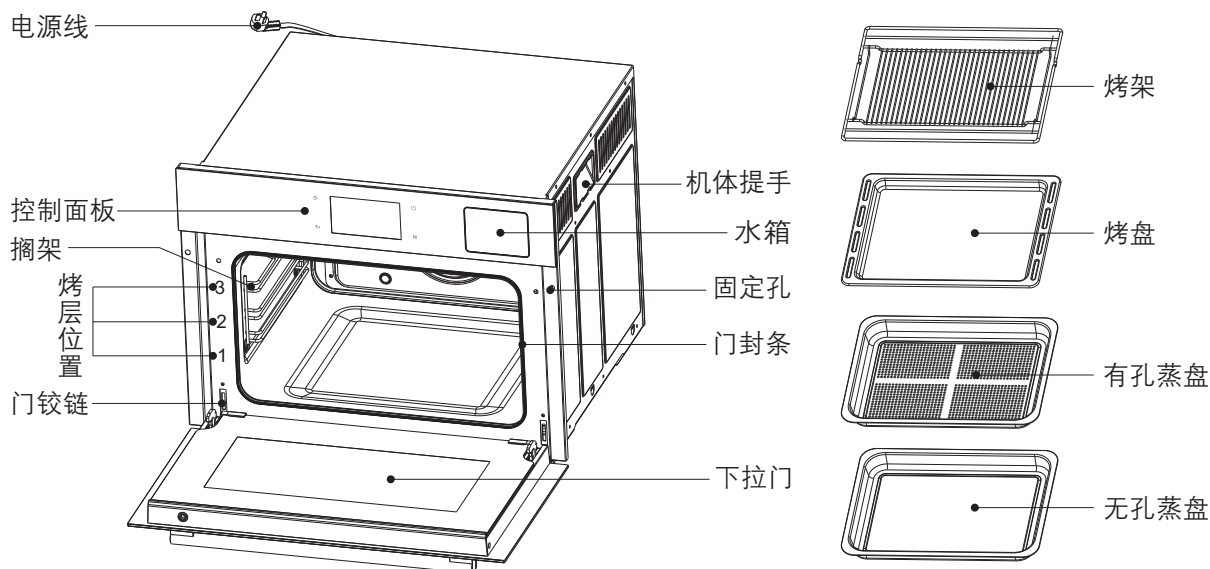

- 注：● 烤盘不能在蒸功能下使用；
● 蒸盘不能在烤功能下使用；
● 根据烹饪的需求，可将蒸盘、烤盘、烤架平稳放置于1、2、3搁架轨道间，推到底即可。

产品技术参数

型号	KZQC-40-CQ751
额定电压	220-240V~
额定频率	50-60Hz
额定功率	2400W
容积	40L
净重	37.3kg
外形尺寸(mm) 宽×高×深	595×455×520

附件清单

序号	名称	数量
1	说明书	1份
2	安装螺钉	2枚
3	烤盘	1个
4	烤架	1个
5	有孔蒸盘	1个
6	无孔蒸盘	1个
7	除垢剂	1盒

※风焙烤作为能效测试模式。

安装说明

在橱柜的设定位置上，按下面安装图示设定方孔，将器具平稳嵌入该方孔，注意不得倾斜安置，具体开孔尺寸（mm）见下表：

序号	名称	A	B	C
1	全嵌开孔尺寸（宽×高×深）	600	460	565
2	半嵌开孔尺寸（宽×高×深）	560	450	550

（图片仅供参考，以实物为准）

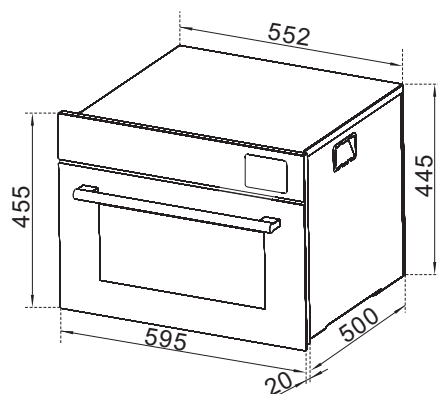

整机尺寸示意图

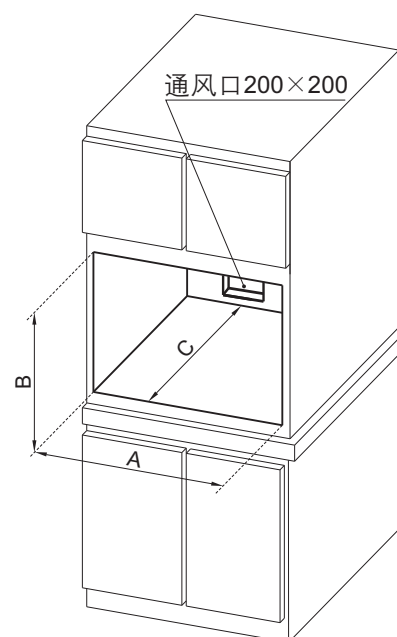

半嵌开孔示意图

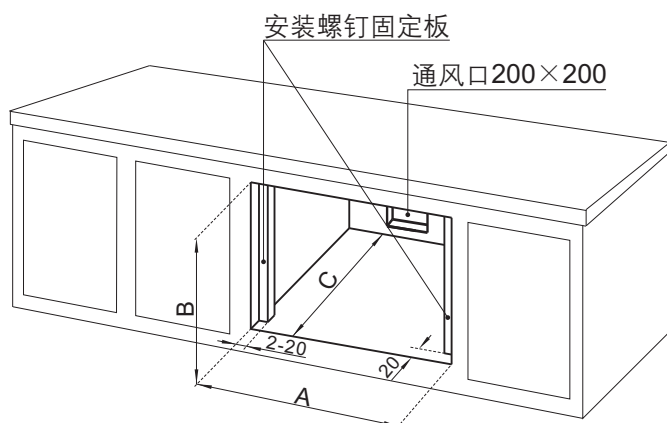

全嵌开孔示意图

安装要求：

- 放置器具的橱柜平面或台面必须水平。
- 橱柜内尽量使器具周围空气流通，建议夹板和固定板采用防潮、防水、防腐蚀、不可燃绝热材料。
- 用所配的两颗安装螺钉，通过左右门框上的固定孔，将机体固定在橱柜上。

电源要求：

- 对于永久性安装，电路必须装有相应的切断及保护装置，连接电源插头和插座应为同一型号并符合当地相关规定。
- 电源线接插必须方便，确保器具安装后可随时断开电源。单独使用**13A**或以上的插座，请勿与几个电器同时使用同一个电源插座，并确保插座安全有效接地。
- 周边若有其他电器，请确保安装距离大于100mm。

使用说明

以下使用说明书中的所有界面图示仅供参考，实际屏幕与APP界面以最新版本为准。

控制面板介绍

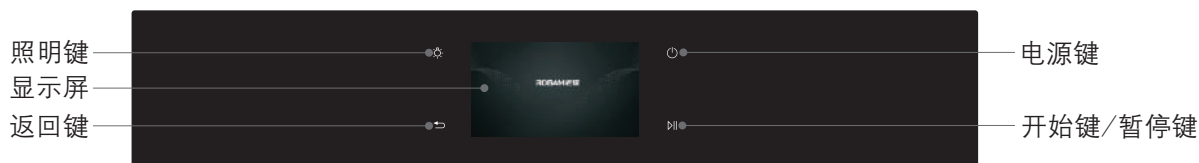

⏻ 电源键

在关机状态下长按此键，进入开机状态；在开机状态下长按此键，进入关机状态。

▶|| 开始键/暂停键

功能选择后，按此键启动工作，一分钟左右进入屏保页面，点击屏幕任一位置，回到工作状态；在工作时按此键，暂停工作。

↶ 返回键

按此键返回到上一页面，或返回到首页；工作时按此键弹出“Cancel?”对话框，弹出“OK”和“Cancel”按钮。

☼ 照明键

在通电状态下，按此键可开启照明功能，再按此键可关闭照明功能，若不按，数分钟后自动熄灭。

使用前说明

●首次使用产品时都会有异味发出，是由于储存期间加热元件有涂层保护，加热后涂层蒸发所致，所以先使房间保持通风，选择高温蒸功能，设定最高温度及最长工作时间，在没有食物的情况下进行工作，工作结束后，再使用干燥功能将产品内的水分烘干，确保后续烹饪的美味度。

●水箱加水及安装注意事项：

1. 在开机状态下，按“↓”图标，水箱自动弹出，取出水箱(如右图)；
2. 使用前先检查水箱是否干净，如有异味或脏污请及时清洗，切勿用开水清洗；
3. 打开水箱盖将水加入水箱中，加水量切勿超过最高水位线；
4. 将加完水的水箱推入水箱槽内，水箱推到位后，会有鸣叫提示。

注：●禁止将热水加入水箱中，以免造成水箱变形及机器损坏；

- 缺水时，显示屏会显示“水箱缺水”报警页面；
- 所有使用蒸功能或加湿功能，关机后，水泵启动，进行余水回收。

温馨提示：产品在使用时，建议您打开吸油烟机。

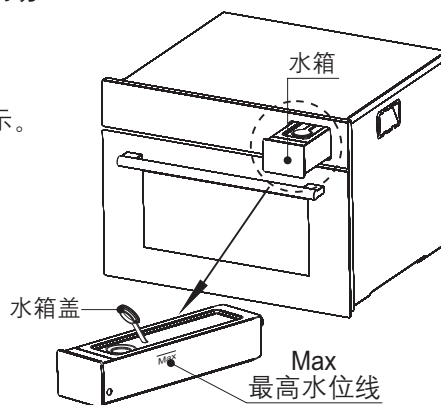

使用方法

1. **通电** 首次接通电源，发出提示音，显示屏显示开机页面。



注：在关机状态下，按“⏻”键开机。

2. 选择烹饪方式

蒸 蒸功能

- ① 点击首页“蒸”图标，显示屏进入蒸功能设置页面；
- ② 选择模式；
- ③ 设置所需的温度、时间；
- ④ 设置完成后，按“▶▶”键启动，自动进入预热模式，当达到预热温度时发出提示音，按“▶▶”键暂停，此时将食物放入内腔，再按“▶▶”键启动，工作完成时，蜂鸣器鸣叫提示。

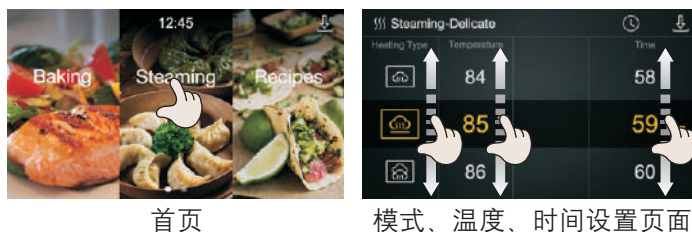

首页

模式、温度、时间设置页面

注：蒸功能烹饪完成后，建议将内腔擦干，或使用干燥功能烘干。

烤 烤功能

- ① 点击首页“烤”图标，显示屏进入烤功能设置页面；
- ② 选择模式；
- ③ 设置所需的温度、时间；
- ④ 设置完成后，按“▶▶”键启动，自动进入预热模式，当达到预热温度时发出提示音，此时将食物放入内腔，工作完成时，蜂鸣器鸣叫提示。

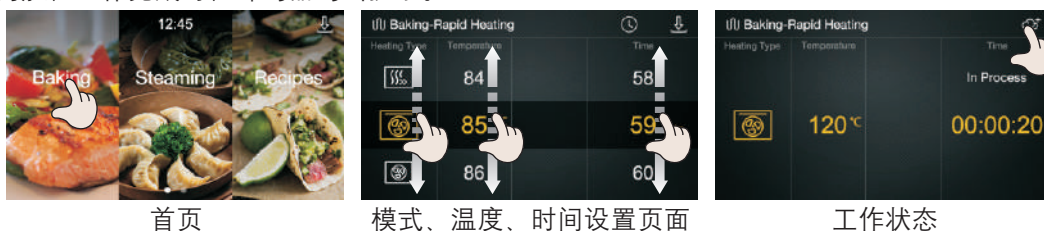

首页

模式、温度、时间设置页面

工作状态

注：●在工作状态下，可按显示屏右上角“☁+”图标，启动蒸汽加湿功能，可增加食物的湿润度，该功能只持续一分钟，一分钟后停止加湿，若想持续加湿，可再次按“☁+”图标即可。
●工作结束前两分钟，不能使用蒸汽加湿功能。

ROBAM老板 | 蒸烤一体机

菜谱功能

- ① 点击首页“菜谱”图标，显示屏进入菜谱设置页面；
- ② 选择菜谱类别；
- ③ 选择菜品；
- ④ 设置所需的时间；
- ⑤ 设置完成后，按“▶||”键启动，自动进入预热模式，当达到预热温度时发出提示音，按“▶||”键暂停，此时将食物放入内腔，再按“▶||”键启动，工作完成时，蜂鸣器鸣叫提示。



☰ 点击此图标可查看烹饪详细信息（食材、备菜、工具）

注：在菜品设置页面中，因菜品的不同，所以规格、时间栏的调整也有所区别，部分菜品不能进行规格、时间调整，请以产品实际显示为准。

多段功能

为满足用户多样化口感，特设多段功能，该功能可设置三段不同的方式对食物进行烹饪。

- ① 点击首页中“多段”图标，显示屏进入多段烹饪选择页面，点击“1”第一段图标，进入模式、温度、时间设置页面进行设置，再点击“▶||”键，确认第一段烹饪方式；
- ② 点击“2”第二段图标，进入模式、温度、时间设置页面进行设置，再点击“▶||”键，确认第二段烹饪方式；
- ③ 点击“3”第三段图标，进入模式、温度、时间设置页面进行设置，再点击“▶||”键，确认第三段烹饪方式；
- ④ 三段烹饪方式都设置完成后，再按“▶||”键启动，当达到预热温度时发出提示音，按“▶||”键暂停，此时打开门将食物放入内腔，再按“▶||”键启动，工作完成时，蜂鸣器鸣叫提示。



注：该功能至少需要设置两段烹饪方式，才能启动功能。

辅助功能

点击“辅助”图标，显示屏进入相应工作页面，客户可根据需求选择相应功能，选择完毕后，按“▶||”键启动，完成时，蜂鸣器鸣叫提示。



首页

辅助工作页面

选择相应功能

注：●清洁保养：包括干燥、清洁、除垢三种功能，点击对应的图标后，按“▶||”键，显示屏有相应的提示，客户按提示操作即可(注:该功能无法暂停)；

●除垢功能：使用前先添加30克除垢剂，工作时间累积50小时后会提醒用户进行除垢（50小时是指在产品不断电的工作情况下，若中间断电会重新开始计时，建议用户使用产品50小时后，进行除垢，**在运行完除垢第一阶段后，除垢提醒即可清除并重新计时，但仍然建议用户完整执行完除垢的三个阶段。**）；

●解冻功能：可按客户需求调整温度和时间；

●杀菌功能：时间和温度为默认值不可调节。

预约功能

例：当前时间为上午10点45分，客户想预约上午11点30分开始烹饪，具体操作如下：

- ① 先选择烹饪方式，设置好烹饪模式、温度、时间；
- ② 点击“🕒”预约图标，进入预约时间设置页面；
- ③ 将小时位调整到11，将分钟位调整到30；
- ④ 按“▶||”键进入预约状态；
- ⑤ 当到达所设定的时间后，进入工作状态，直至工作结束。



模式、温度、时间设置页面

预约时间设置页面

预约状态

注：●预约中，按“▶||”键，按当前设置的模式开始工作；

●预约时间是指开始烹饪的当地时间；

●使用预约功能前，请确保产品当地时间显示准确；

●该功能不是所有模式都适用，右上角如显示“🕒”图标，可进行预约设置，若无此图标不能进行预约设置，请以产品实际显示为准。

设置 设置功能

■ 时间调整

- ① 点击首页中“设置”图标，显示屏进入设置功能页面；
- ② 点击“时间”，进入时间设置页面，进行小时位、分钟位设置；
- ③ 设置完成后按“▶||”键确认。



首页

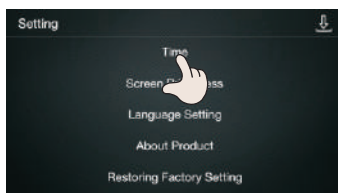

设置功能页面

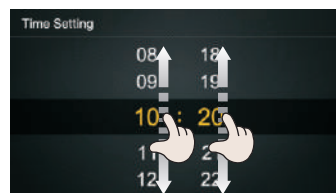

时间设置页面

注：● 在使用预约功能时，需将机器显示时间与当地时间调至相同，否则会影响预约烹饪开始时间。
● 设置时间为24小时制。

■ 屏幕亮度调整

- ① 点击首页中“设置”图标，显示屏进入设置功能页面；
- ② 点击“屏幕亮度”，进入亮度设置页面，设置完成后按“▶||”键确认。

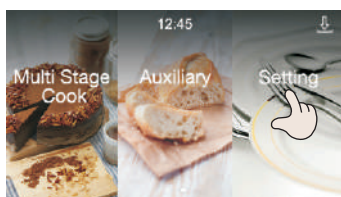

首页

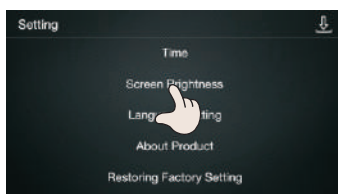

设置功能页面

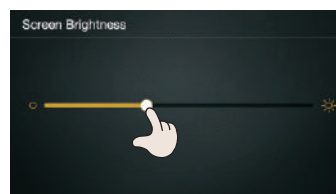

亮度设置页面

■ 关于产品

- ① 点击首页中“设置”图标，显示屏进入设置功能页面；
- ② 点击“关于产品”，显示产品信息；
- ③ 点击“←”键，回到上一页面。

■ 恢复出厂设置

- ① 点击首页中“设置”图标，显示屏进入设置功能页面；
- ② 点击“恢复出厂设置”，进入相应页面，按提示操作即可；
- ③ 完成后，点击“←”键，回到上一页面。

3. 工作结束

- ① 工作结束后发出提示音，显示屏显示“完成”和“加时”页面，点击“完成”进入首页或长时间无操作后，进入关机状态；
- ② 若客户想增加烹饪时间，点击加时图标进入加时设置页面，进行加时设置（加时时间最长10分钟），完成后按“▶||”键继续按原来的模式、温度工作；结束后再次回到“完成”和“加时”页面，如此循环；

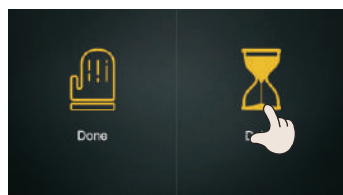

完成、加时页面

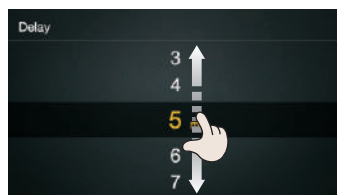

加时设置页面

- ③ 在开机状态下长按“”键，进入关机状态；
- ④ 在长时间无任何操作后自动关机。

注：● 如产品内部温度过高，散热风机会延迟一段时间后停止运转，有利于延长机器寿命。
 ● 为缩短散热时间，建议散热时将产品门打开。
 ● 多段功能完成后，显示屏只显示“完成”。

烘烤时常见现象及处理

现象	原因分析	处理
烘烤不均匀	*烤层位置不正确 *食物没有放烤盘居中位置 *功能选择不正确	*选择适合的烤层位置 *把食物放在烤盘居中位置 *选择正确的功能
烤出的食物上表层颜色或底部颜色较深	*功能选择不正确 *食物大小不一或食物未放均匀 *烘烤温度太高 *烤层位置太高或太低 *烘烤期间烤箱门开的次数太多	*选择正确的功能 *食物大小切均匀，并在烤盘上放均匀 *调低温度 *改放到低一层或高一层的位置 *至少烤到一半时间才可以开一次门
烤出的糕饼有裂缝和深厚的锅巴层	*时间太长 *烘烤温度太高 *制作糕饼配方或操作过程有误 *容器选择不正确	*调整时间 *调低温度 *调整配方，正确操作流程 *更换适合的容器
烤出的食物颜色浅及未烤透	*烘烤温度太低 *烘烤时间太短	*调高温度 *延长烘烤时间

加热模式

功能	默认工作温度 (°C)	默认工作时间 (min)	温度范围 (°C)	时间范围 (分钟)
快热	200	30	50-230	1-120
风烘烤	200	30	50-230	1-120
烘烤	160	30	50-230	1-120
底加热	160	30	50-180	1-120
风扇烤	220	30	50-230	1-120
烤烧	180	30	50-230	1-120
强烤烧	180	30	50-230	1-120
EXP	上160 下140	20	100-200	1-120
快速预热	180	90	50-230	-
煎烤	150	30	50-230	1-120
保温	60	120	40-90	-
果蔬烘干	60	30	50-80	1-120
解冻	60	20	40-80	1-120
鲜嫩蒸	90	20	90-95	1-120
营养蒸	100	20	96-105	1-120
高温蒸	120	20	106-150	1-120
发酵	38	60	35-60	1-120

注：用户可根据此表的加热模式，了解其加热方式，选择适合的烘烤功能。

维护和保养

重要提示：清洗蒸烤一体机前，必须先切断电源。

必须始终保持器具的清洁，确保发热元件、风扇周围没有积聚脂肪和油腻；烤盘和烤架等必须清洗干净，以免脂肪积层引发火警；肉食在烘烤时可用铝箔纸包裹，以便清洁；任何脂肪和油腻都会在器具内结成一层漆状积层，难以清洗，所以在每次使用后应清洁干净。

1. 内腔：用温水清洗，不要使用具有腐蚀性和具有研磨性的清洁剂清洗。难去除的污渍可用尼龙刷或中性清洁剂清洗，不可用钢丝球擦洗，以免造成表面不可修复的损伤。腔内的清洁剂必须清洗干净不能有残留，清洗后并用抹布擦干，保持腔内干燥，或者使用干燥功能烘干。

2. 玻璃面板：门和控制板上的玻璃面一受脏就要立即清洁，牢固的污垢可用中性清洁剂清洗，不可用钢丝球擦洗，以免划伤表面，清洗后用抹布擦干。

3. 每次使用后，请取出水箱将水倒掉以免时间过久会产生异味。

4. 使用后必须及时把集水槽中的积水清理干净，防止水溢出。

5. 拆、装风机盖板：风机盖板是用4颗螺钉固定在腔体内部，逆时针旋下螺钉即可拆下风机盖板。

注：风机盖板清洗以后务必重新装回。

6. 拆、装搁架(左、右搁架方法一致)：按压搁架①的位置(图1)，直至搁架离开定位螺钉，按(图4)箭头向上取出，即可拆卸。重新装上搁架，按(图2)中将搁架下端对准螺钉1、2插入，再将搁架上端扣入定位螺钉即可。

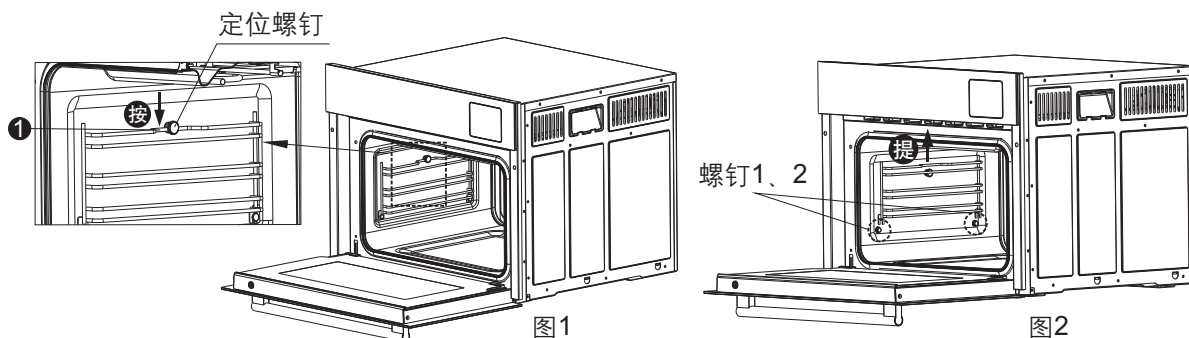

7. 双手捏到门封条上边左右两个A、B半圆角处，对准前板上边的半圆角沟槽，用力压入；再将下边左右两个C、D半圆角处，对准前板下边的半圆角沟槽，用力压入；再分别将四条边完全压入到沟槽内，压入后确保平整、不起皱，无缝隙。

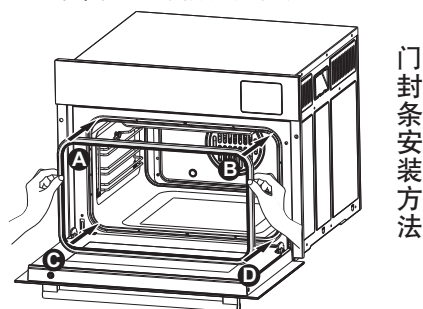

常见故障及处理方法

下表所列为一故障，请按所列指示进行确认和处理，如仍处理不了或不能确认故障原因时，请与当地经销商或售后服务中心联系。为了您的安全着想，我们特别提醒：请勿自行拆卸修理。

故障现象	原因	处理方法
不能工作	是否停电、电源插头是否插好	待通电后使用
显示屏不亮	电源不通或者电脑板故障	检查电源情况或请专业人员维修
照明灯不亮	电源不通或灯泡故障	检查电源情况或请专业人员维修
工作时有漏气漏水现象	门没关紧、门封条未装到位或门封条损坏	检查门关闭情况、重新安装门封条或请联系专业维修人员
显示屏显示“水箱缺水”	水箱缺水或水位检测开关、水泵故障	添加水或联系专业维修人员
温度无法上升	蒸汽发生器、电脑板、温度传感器故障	请联系专业维修人员
工作中突然黑屏	温控器保护、电脑板故障	请联系专业维修人员
水箱无法弹出	推杆电机故障、电脑板故障	请联系专业维修人员
显示屏显示设备内的温度传感器故障	温度传感器故障、电脑板故障	请联系专业维修人员
显示屏显示设备内的风机故障	散热风机故障、电脑板故障	请联系专业维修人员
显示屏显示设备内通信故障	通信故障（显示板连接线异常）、电脑板故障	请联系专业维修人员

警告：在使用前，请将水箱推压到位。

电气原理图

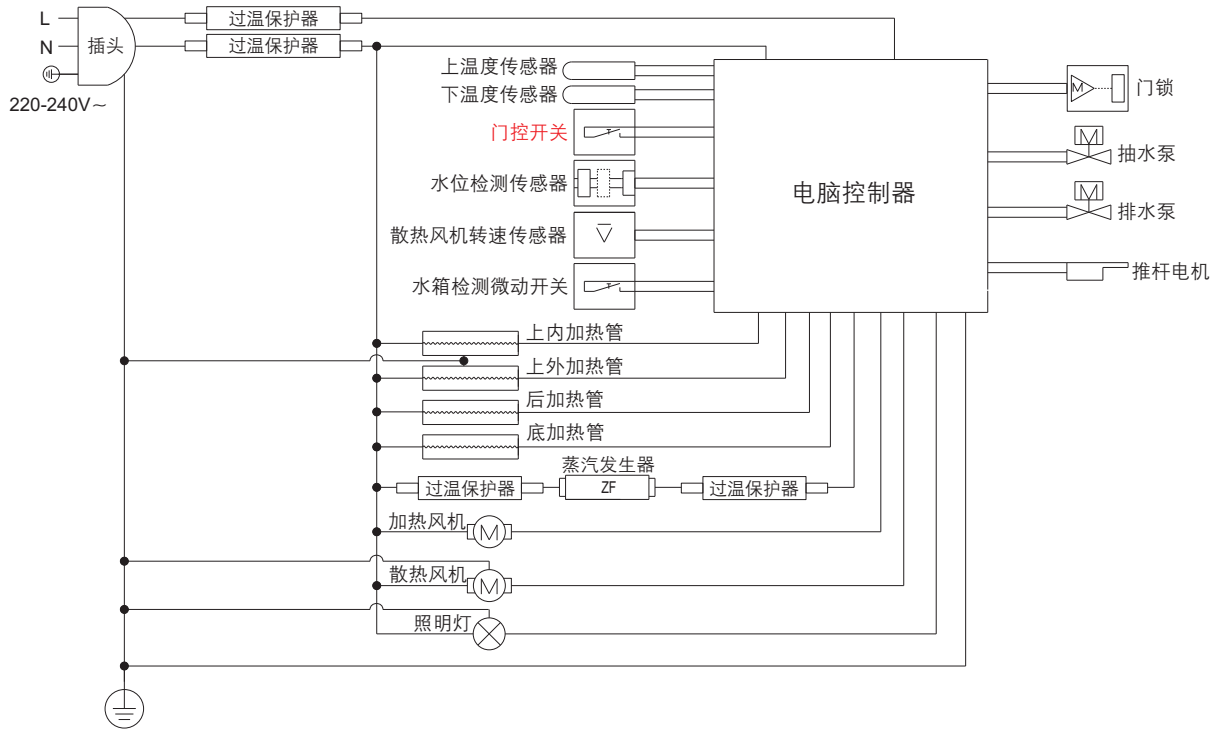

Edition: A/0
Publication Date: July,10,2020
版次: A/0
出版日期: 2020年7月10日

ROBAM